



# underground mining.



As a recognized leader in custom engineered underground ropes, Bridon-Bekaert's brands have supplied some of the world's deepest mines with the harshest operating conditions for decades. Our product range is unmatched in the industry, as is our capability to design the best rope for any application.

Through innovation, Bridon-Bekaert goes beyond offering rope constructions traditionally supplied by our competitors. We strive to develop new designs which combine the benefits of existing types without the inherent downsides. We listened to our clients and created Cushion-Pac 35™, a revolutionary hoist rope that has become an instant success in the underground mining market.

Bridon-Bekaert Ropes Group is the world's premier supplier of mission-critical advanced cords, steel wire ropes, and fibre synthetic ropes.

As a leading innovator, developer and producer of the best performing ropes and advanced cords globally, the Group provides superior value solutions to the oil & gas, mining, crane, elevator and other industrial sectors.

Two of the most enduring wire and rope pioneers joined forces in 2016 to make this ambition real. Bridon-Bekaert Ropes Group has a global manufacturing footprint and employs approximately 2500 people worldwide.



# capabilities.

Bridon-Bekaert operates the largest 8-bobbin closer in the Americas, with a capacity of 120 metric tons, as well as a range of sophisticated stranders, including one of the fastest machines in the world. We also employ industry-leading extrusion lines, with a proprietary process developed over two decades of making large plasticized ropes.

A combination of versatile machinery and more than 125 years of experience gives Bridon-Bekaert Ropes Group the ability to manufacture an unmatched range of high-end products:

- ✓ 6 or 8-strand ropes up to 8" (203mm)
- ✓ Large plasticized ropes up to 6" (152mm)
- ✓ Structural strand up to 6" (152mm)
- ✓ Triangular flattened strand ropes
- ✓ Full-lock and half-lock coil ropes
- ✓ Cable laid ropes up to 12" (305mm)
- ✓ Long continuous lengths up to 29,000' (8.8km) of 2" (51mm)

These capabilities allow us to supply ropes for some of the largest equipment in use today, including dragline excavators and long cable belt conveyor systems. We regularly supply major supported roof structures, suspension bridges and communication tower projects around the globe. In addition to our current lineup, we can custom design and manufacture unique ropes to the specific requirements of your application.

# certifications.

## ISO 9001 Certified

Bridon-Bekaert is committed to quality assurance. All employees are working under a ISO 9001:2008 registered quality management system, from the shop floor to the executive office.

At WRI, we strive to:

- ✓ Fulfill the customer's quality requirements
- ✓ Conform to applicable regulatory requirements
- ✓ Enhance customer satisfaction
- ✓ Achieve continuous improvement



## API Certified

For more than 75 years, API has specialized in the development of petroleum and petrochemical equipment and operating standards. As an authority for modern Oil & Gas industrial equipment, API maintains more than 500 standards and recommended practices, of which many have been incorporated into state and federal regulations.

For more information, visit [www.api.org](http://www.api.org)

API Quality Certification applies to:

- ✓ Material supplier qualification
- ✓ Employee training and education
- ✓ Coordinated and planned inspections
- ✓ Audit and corrective actions
- ✓ Document verification
- ✓ Consistency through procedures
- ✓ Equipment calibration and maintenance

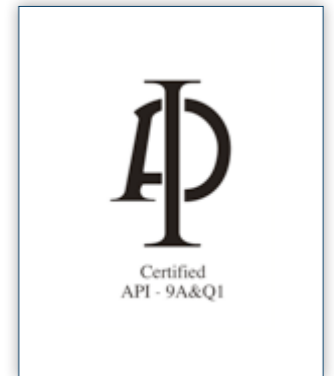

## Lloyds Register

Lloyds Register provides independent assurance to companies operating high-risk, capital-intensive assets in the energy and transportation sectors, to enhance the safety of life, property and the environment. This helps Bridon-Bekaert to create safe, responsible and sustainable supply chains.

The Lloyd's Register Group is one of the world leaders in assessing business processes and products to internationally recognized standards.

For more information on this, please visit <http://www.lr.org>



# quality.

Our multiple certifications by recognized regulatory bodies testify to our drive to bring the best quality and value product to our clients. We uphold our high standards of quality by employing the following processes.

#### Material supplier qualification

We run one of the most stringent supplier qualification programs in the industry. Our business is built on the consistency and quality of raw materials.

#### Employee training and education

We constantly improve competencies of our employees through supporting ongoing education and training programs and ensure that they have the correct tools to excel in their jobs.

#### Equipment calibration and maintenance

Calibrated and well-maintained equipment leads to greater product consistency and on-time delivery.

#### Coordinated and planned inspections

Planned inspections assure product consistency and conformity to specification.

#### Consistency through procedures

Documented and maintained procedures ensure all employees use the same work methods.

#### Audit and corrective actions

Internal audits and corrective actions ensure systems are effective and that continuous improvement is realized

#### Document verification

Formalized and monitored documentation allows for the complete tracking of product, processes, and materials.

#### Quality monitoring through inspection and testing

We monitor the quality of incoming materials, semi-manufactured products during manufacturing, and final products to ensure the quality standards are met before shipment.

#### Breaking load verification

Computerized destructive testing confirms the actual breaking load of individual rope and strand.

#### Field simulation through cycle testing

Fatigue cycle testing, simulating field conditions, verifies actual rope fatigue life.

#### Statistical Process Control (SPC)

We perform process capability studies to maintain and improve the quality of our manufacturing operations. Continuous measuring devices and procedures allow us to monitor if the process consistently meets specifications. They are also used to define control limits, which are used to flag inconsistencies and trigger immediate corrective actions. Ongoing SPC training for supervisory and operator personnel ensures adherence to procedures and that equipment is operated to peak efficiency.

# services.

#### Consulting and Training Services

Bridon-Bekaert's ability to combine operational analysis with higher performing products allows us to provide improvement recommendations including high performance rope solutions, maintenance and inspection procedures, and potential equipment operating strategies.

Rope analysis and inventory assessment permits our clients to consider the types of ropes in use on their equipment and rationalize inventory based on the best performance solutions

On-site inspection and analysis of customer ropes, equipment, and operations allows for the verification of rope condition and the identification of potential operational problems.

Underground mining consulting for new mine shafts including the selection of ropes and attachments, installation recommendations, and performance cost assessments permits our mining clients and their consultants to consider various types of rope hoisting systems and the associated cost/maintenance implications.

Specialized mine maintenance and engineering seminars, conducted by Wire Rope Industries personnel with over 25 years of mining experience, allows our clients to deal with the highly technical and critical demands of their individual operations.

On-site rope and assembly seminars, focusing on product selection, proper use, handling and inspection provide operators and riggers with the information necessary to use our products safely and securely while optimizing performance.

#### Lab testing and analysis

Detailed lab analysis, testing, and reporting allow for the specific verification of rope failure modes and identify possible rope and operational improvements.

#### Pre-stretching and Proof-loading

We are equipped with facilities capable of applying up to 800,000 lbs tensile force. Prestretching facilities include hydraulic grips at each end allowing unlimited lengths of finished assemblies. Standard length accuracy of assemblies is  $\pm 1/8"$  per 100 feet for rope or strand up to  $\pm 1/2"$  per 1000 feet.

#### Socketing, Proof-loading, and Certification

For maximum worker security and product quality, Bridon-Bekaert is capable of conducting a full range of socketing, pre-stretch (proof-loading), and certification services. We can socket products up to 6" (153mm) in diameter and use epoxy resin, zinc, or custom socketing compounds upon request.

#### Custom Rope Engineering

Our experienced team of engineers has been developing customized rope designs for specialized application for decades. We can help you assess your operational requirements and develop the best product for your machinery, working conditions, and performance targets.

# research & development.

Drawing from years of engineering expertise, WRI has developed one of the most sophisticated design and testing systems in the marketplace today. Our technologies and precision testing allows us to examine and resolve complex problems quickly and efficiently, ensuring optimum performance for each design.

Our Test Lab and Field Facilities provide us with the following capabilities:

- ✓ Our in-line EM testing equipment for underground mining ropes is capable of detecting broken wires, rope distortion, and establishing the baseline for loss of metallic area verification during rope life.
- ✓ Tensile testing of ropes up to 180 metric tons and all types of wire
- ✓ Evaluation rotation and modulus of wire ropes
- ✓ Actual bending fatigue cycle testing under load, to simulate field conditions and optimize designs using two proprietary fatigue testing machines
- ✓ Metallurgical analysis, including full chemical and structural analysis of all steel components, allows for optimum wire selection for each design.
- ✓ Specialized material testing on key components such as lubricants, plastics and synthetics allows for the selection of the most appropriate materials for our designs
- ✓ Field sample analysis allows us to verify design parameters and development new ideas for improvement by comparing laboratory test results with actual customer samples.

## Your feedback is important

A majority of our technical innovations come from customer feedback. Aftersales relationships are as important to Wire Rope industries as they are to our customers. We rely on field data to improve our products and bring more value to your operations.

## Joint Product Development

We developed some of our most successful products through relationships with our long-term clients. We strive to understand the challenges that our clients face in their operations in order to be able to develop performance solutions for them. This process is especially fruitful when both sides understand the benefits and are open to employ their engineering resources towards the same goal. Contact us and learn how we can work together to develop custom solutions tailored to your needs.

## BBtec

The Bridon-Bekaert Technology Centre (BBtec) is our centre of excellence for rope technology development, testing, analysis and verification.

BBtec is equipped with unique equipment capable of testing steel/synthetic ropes and wires. It has extensive forensic analysis laboratory facilities and specialists capable of conducting detailed forensic evaluation of new or retired ropes.

BBtec accelerates Bridon-Bekaert's new product development, involving the latest rope technologies to increase safety, performance and operational life of ropes working in demanding and hostile environments typical to our core markets in the Oil and Gas, Mining, and Construction sectors.

# feature clients.



## POTASH, NICKEL, & GOLD MINING

### Canadian Mining industry

Bridon-Bekaert Ropes Group has played a leading role in the development of the underground mining industry in Canada. We have decades-long relationships with all major miners of potash, gold, iron ore, and nickel, in some of the deepest shafts in the world (over 1000m). Our clients have tested and installed generations of innovative products, with our new Cushion-Pac 35™ hoist ropes being a major success in the latest round of mine expansions.

## IRON ORE MINING

### North Sweden

Our flagship client operates the largest and most technologically advanced underground iron ore mine in the world. The mine currently operates hoisting system which is currently being upgraded to capacity of 37 million tonnes per year. Bridon-Bekaert Ropes Group has been the primary supplier of all shaft ropes for this client since 1997, providing the most advanced solutions available on the market. This close relationship has fueled innovation on both sides, resulting in next generation of hoist ropes with leading anti-corrosion properties as well as practical solutions which significantly reduced rope change-out intervals.

# application selector.

# diagrams.

	PRODUCTS	FRICTION HOIST	DRUM HOIST	BALANCE	GUIDE	SHAFT SINKING
Premium Ropes	 Cushion-Pac 35	✓	✓			✓
	 Tri-Pac & Tri-Max	✓	✓			
	 Power-Loc FLC	✓				✓
	 Power-Loc HLC				✓	
	 Cushion 34				✓	
	 DyPac 34		✓	✓	✓	
Standard Ropes	 PS 3410	✓	✓	✓		✓
	 PS 1810	✓	✓	✓		✓
	 PS 620	✓	✓			

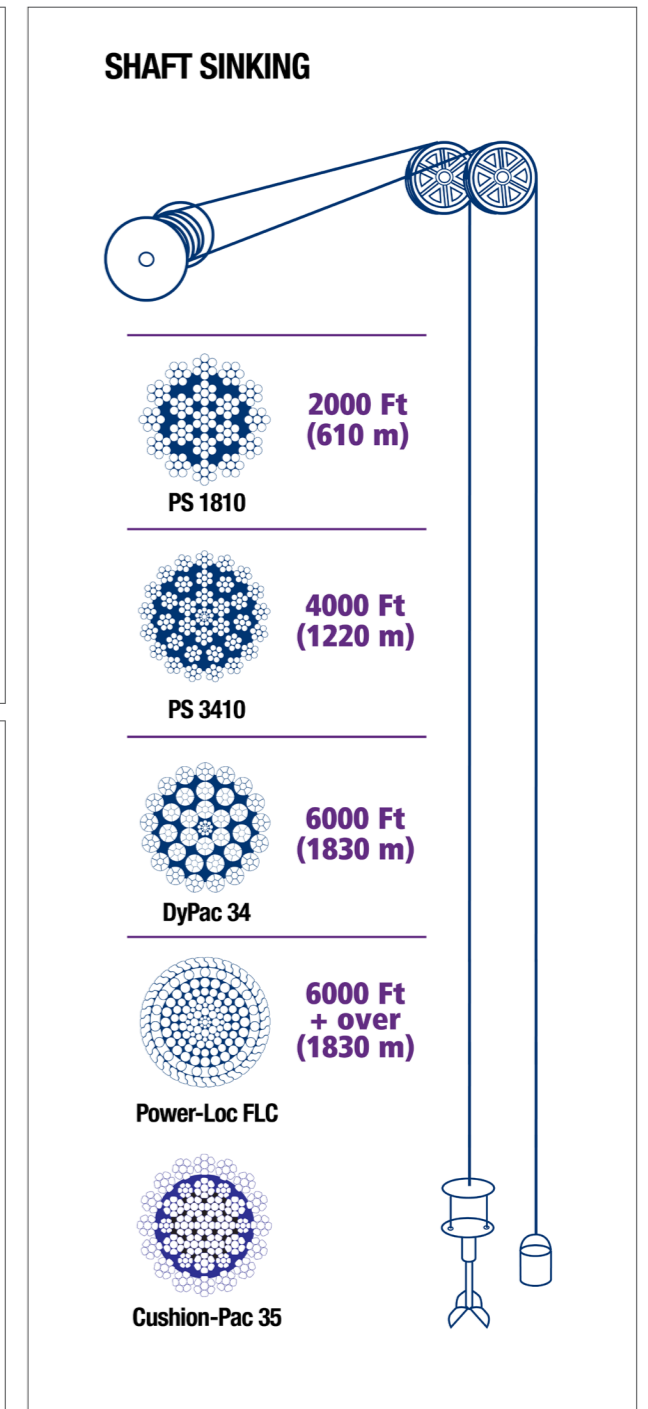
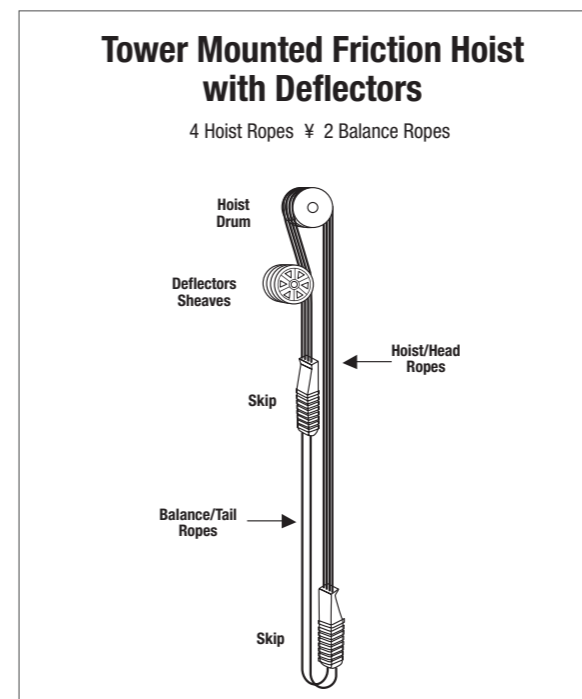
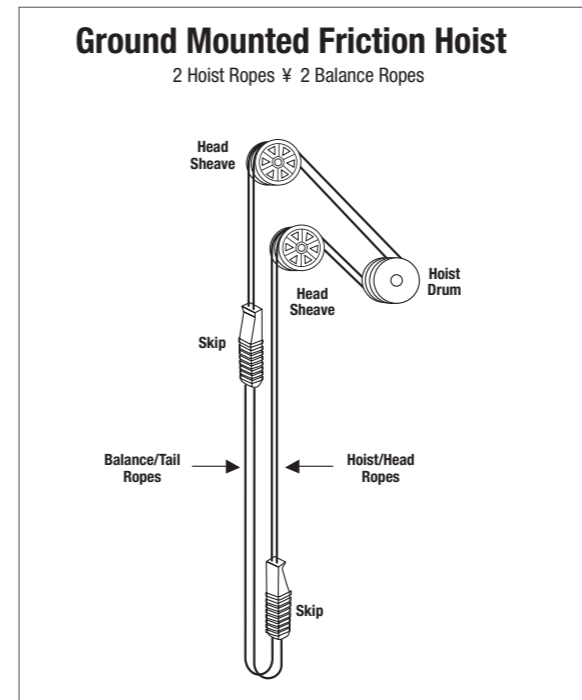

# product overviews.



## Cushion-Pac 35™

### New Rotation-Resistant Friction (Koepe) Hoist Rope

WRI's latest product combines the flexibility of triangular flattened strand ropes with non-rotational resistance required for installation in deep shafts which was until now only available with full-lock coil construction. The result has redefined our clients' expectations with the most versatile hoisting rope on the market.

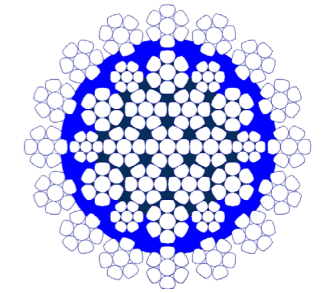

- ✓ **Rotation Resistant**  
Rotation resistance allows the Cushion-Pac 35 to be used in modern deep shaft mines  
Low torque means easier handling during installation and maintenance
- ✓ **Flexibility**  
More flexible than full-lock coil ropes  
Less susceptible to structural upset
- ✓ **Minimal Elongation**  
The parallel lay construction of the core coupled with the compacting of the outer strands give the Cushion-Pac 35 a very high metallic area, which keeps the elongation to a minimum
- ✓ **Compacted Outer Strands**  
Increased breaking load and fatigue life  
Smooth outer surface provides larger contact area with drum & sheaves for increased wear resistance and superior traction Is compatible with existing polyurethane liners
- ✓ **Plastic Jacketed Core**  
A physical separation between the outer strands and the core that effectively seals in the core lubricant and ensures the proper positioning of the outer strands
- ✓ **Superior Lubrication**  
Outer strand lubricant is specifically formulated for Koepe friction winder applications  
Core lubricant offers optimal protection against steel-to-steel abrasion for superior fatigue life

#### Features and Benefits

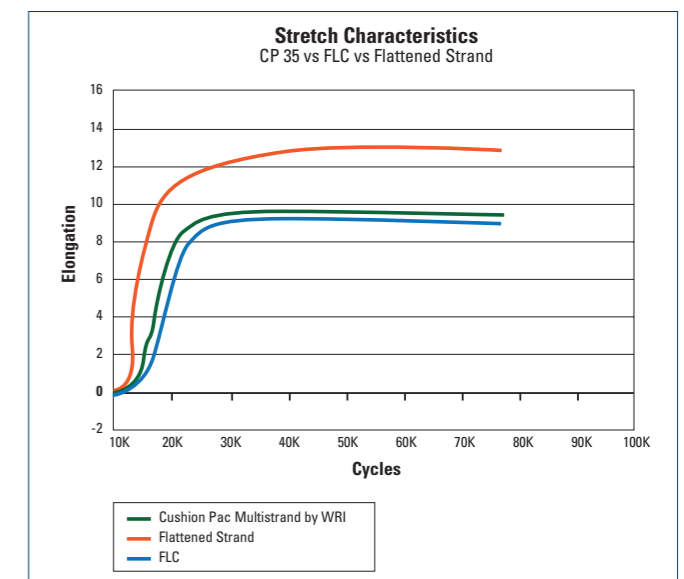
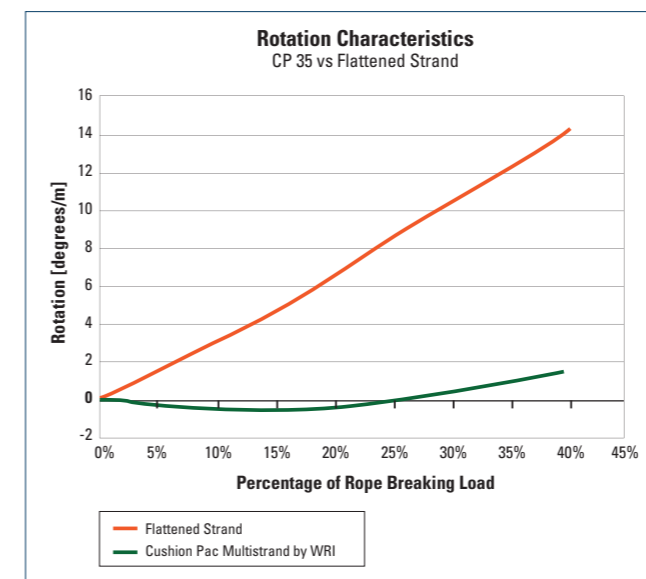



## Tri-Max FS™ & Tri-Pac FS™

### Triangular Flattened Strand Hoist Ropes

A well-proven 6x27 lang-lay flattened triangular strand construction provides 2.5 times the contact area of a round strand rope.

Designed for increased rope strength, wear resistance and fatigue life, and exceptional resistance to drum crushing.

The (3/3) triangular strand center construction provides the best strength/performance combination for drums with a recommended D/d ratio of 80/1.

An optional (6/1) brangle strand center construction provides improved flexibility and fatigue life on drums with smaller D/d ratios.

Custom design capabilities and a full wire tensile range from 1770MPa (115 Long Tons/In<sup>2</sup>) to 2160 MPa (140 Long Tons/In<sup>2</sup>) ensure that rope can be designed to meet individual customer requirements.

A specially manufactured core increases rope life by significantly reducing stretch, providing a more consistent density and diameter to support the strands, resisting strand abrasion, and eliminating core rot caused by corrosive environments.

Specially formulated lubrication increases rope performance, reduces corrosion and other effects of shaft environments, and minimizes environmental impact due to fly-off.

#### How Tri-Max™ ropes reduce downtime and create value:

- ✓ Greater rope contact area provides for smoother operation and reduced sheave and drum wear. The optional thermal plastic enhancement of the rope drum end significantly enhances protection of the dead wraps and improves support of the upper layers of rope.
- ✓ Reduces stretch, and limits the number of drum end cuts required. Available high-quality conveyance attachments simplify installation and removal for rope test cuts, ensure maximum rope breaking-load efficiency, and reduce maintenance downtime.
- ✓ Reduction of overall operating costs as a result of improved rope performance and maximized payloads
- ✓ Reduction of equipment downtime due to quicker maintenance turnaround and fewer drum end cuts.

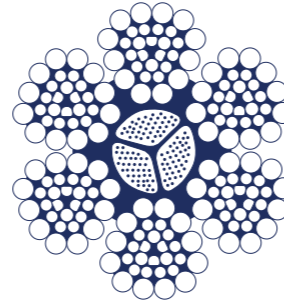

Tri-Max FS™

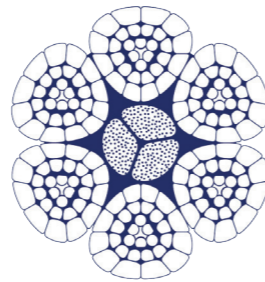

Tri-Pac FS™



## Power-Loc FLC™

### Full-lock coil ropes for friction (Koepe) hoisting applications:

A specialized full locked coil design, developed by WRI, provides one of the highest strength to weight ratios of any rope

Significantly increased cycle life, and reduced stretch compared to round or flattened triangular strand ropes. Power-Loc FLC™ is most effective when installed with a D/d ratio greater than 100-1.

Exclusive manufacturing techniques provide superior rotation resistance and virtually eliminate the natural torque and rotation common to round or flattened triangular strand ropes.

Custom design capabilities and the highest wire tensile range currently available ensure that production capacity can be maximized for each individual hoisting system.

Specially formulated lubrication maintains friction while increasing rope performance, thus reducing corrosion and other effects of shaft environments. The locked coil design has the added advantage of maintaining lubrication inside the rope.

Greater rope contact area and minimal rotation during hoisting provides smoother conveyance operation and reduces drum wear

Good correlation between loss in strength and loss in metallic area during EM testing makes it easier to determine the duration of rope life and to better plan change-outs

Available high-quality conveyance attachments simplify installation and removal for rope test cuts, ensure maximum rope breaking-load efficiency, and reduce maintenance downtime.

#### How Power-Loc FLC™ creates value:

- ✓ Reduced overall operating costs as a result of significantly enhanced rope performance and maximized payloads.
- ✓ Reduced equipment downtime due to fewer scheduled change-outs.
- ✓ Reduced equipment maintenance costs resulting from less drum liner wear and smoother conveyance operation.

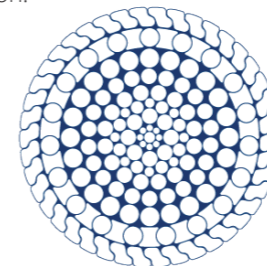

## Power-Loc HLC™

### Half-lock coil ropes for Guide and Rubbing applications

WRI's Power-Loc HLC™ guide and rubbing ropes have five decades of proven track record.

A specially designed half locked coil construction provides excellent rotation resistance, superior wear properties and minimal movement in the shaft when compared to other rope constructions.

Locked coil rope guides provide a cost-effective alternative to rigid wood or metal guides by allowing for reduced shaft sizes and structures, improved air displacement on moving conveyances and minimized damage and wear caused by vibration.

WRI's recommended 9 pair outer wire rope design has less torque and rotation, and is easier to install when compared to 7 pair rope designs.

The smooth outer profile of the rope minimizes vibration, reduces conveyance slipper wear, and provides superior rope performance.

Specially formulated lubrication and recommended maintenance programs extend service life and reduce the corrosive effects of shaft environments.

Optional galvanizing further enhances corrosion resistance and service life. Galvanizing is recommended for the most severe shaft conditions.

High-quality positioning and suspension attachments, long established installation procedures, and qualified WRI technical personnel ensure efficient handling and minimized downtime.

#### How Power-Loc HLC™ creates value:

- ✓ Reduced long-term operating costs as the result of increased service life and trouble-free operation
- ✓ Reduced equipment wear and smoother conveyance operation resulting in lower maintenance costs

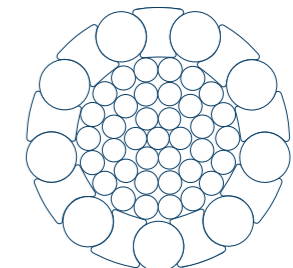





## Cushion 34™

### Plasticized multi-strand ropes for balance applications

A 34x19 construction provides improved flexibility and an approximate natural loop to rope ratio of 45-1.

Multi-strand spin resistance and plastic enhancement allow for smooth in-service operation, significantly reduced rope torque and stretch, and less movement in the shaft when the rope is at full speed.

Full plastic impregnation improves spin-resistance and eliminates internal cross cutting of the strands which is common to other multi-strand products, thereby extending service life and improving security.

Galvanized wire and WRI's patented one-step impregnation and jacketing process, which provides a thick protective outer layer of plastic, prevents contaminants from corroding the rope and eliminates the need for costly in-field lubrication.

A smooth outer rope profile reduces the chance of entanglement and virtually eliminates dirt buildup, thereby maintaining a more constant T1/T2 ratio. Computer-designed custom ropes ensure accurate rope weights which meet specified T1/T2 ratios.

Factory installed sockets are also available

How Cushion 34™ creates value:

- ✓ Reduced overall operating costs as the result of enhanced performance and the elimination of in-field lubrication.
- ✓ Reduced equipment downtime resulting from fewer maintenance requirements.
- ✓ Factory installed sockets dramatically reduce installation time on site

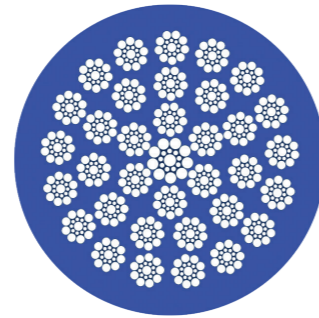

## Dy-Pac 34

### Premium version of PS3410 design

Dy-Pac® strand enhancement of a 34x7 (LCD) construction provides additional performance, an increase in strength of approximately 15%, reduced sheave and drum wear, and significantly enhanced drum spooling. As a result, operating depths can be extended up to approximately 6000 ft (1830 m).

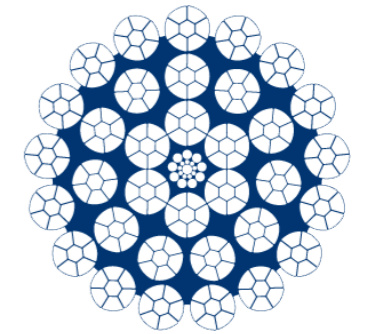

## PS 3410

### Standard rope for shaft sinking, hoisting, and balance applications

A well-proven 34x7 construction provides good flexibility

Multi-strand spin resistance allows for smoother in-service operation, reduced rope torque, and less movement in the shaft.

A specialized Line Contact Design (LCD) improves performance and reduces internal cross cutting damage, common to other multi-strand products. By combining outer lang-lay strands with inner regular lay strands, the underside of the outer strand wires run in the same direction as the wires of the supporting layer.

A specially manufactured core improves rope performance by reducing stretch, providing a more consistent density and diameter to support the strands, resisting strand abrasion, and eliminating core rot caused by corrosive environments.

Specially formulated lubrication extends service life by reducing corrosion and other effects of shaft environments.

How PS 3410 creates value:

- ✓ Reduced overall operating costs as the result of a high performance, cost effective rope design.
- ✓ Reduced equipment downtime as the result of consistent trouble-free operation.

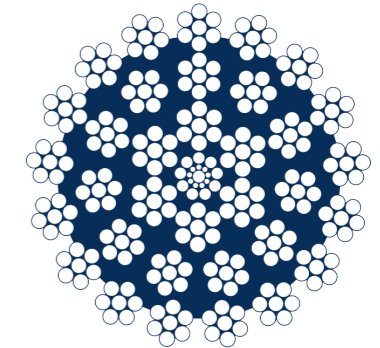



## PS 1810

### Standard rope for hoisting, balance, or shaft sinking applications

A resilient 18x7 IWRC construction and wire tensiles ranging from 1770 MPa (115 Long Tons/In<sup>2</sup>) to 2000 MPa (130 Long Tons/ In<sup>2</sup>) provide the necessary strength and reliability to operate up to depths of approximately 2000 ft (610 m).

A specialized Line Contact Design (LCD) improves performance and reduces internal cross cutting damage, common to other multi-strand products. By combining outer lang's lay strands with inner regular lay strands, the underside of the outer strand wires run in the same direction as the wires of the supporting layer.

Specially formulated lubrication increases rope performance and reduces the corrosive effects of shaft environments.

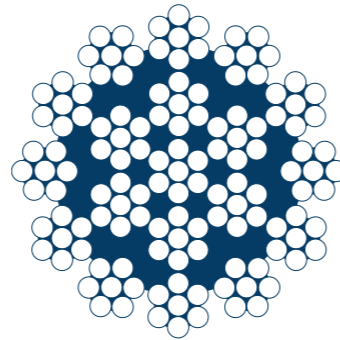

## PS 620

### Standard rope for low-depth hoisting applications

Specially selected wire tensile grades and 6 strand construction enhance wear resistance.

Specially formulated lubrication enhances wear properties, increases rope performance, and reduces environmental impact due to fly-off and the calibrated cut lengths and custom pad eyes simplify installation and reduce down-time.

Excellent value for less demanding applications.

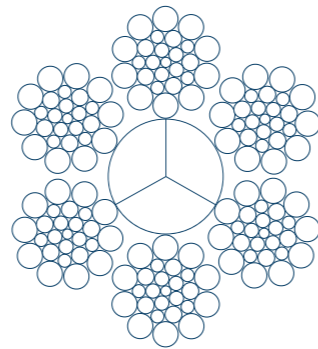

## Bezinal® 3000 Coatings

Developed by our parent company Bekaert, world leader in wire technology, Bezinal® is the next generation of Zinc-Aluminum coating for high-carbon wires.

We offer Bezinal for all our underground mining ropes. Bezinal coated ropes have been used by several of our flagship clients with exceptional results.

#### Benefits

- ✓ Superior corrosion resistance for longer lifetime
- ✓ Exposure up to 350°C leaves the coating intact
- ✓ Cathodic protection
- ✓ Active protection of cut ends
- ✓ Sustained corrosion protection at welded points
- ✓ Good formability
- ✓ Withstands heavy deformations
- ✓ Suitable for cycled fatigue loads

Bezinal® outperforms standard galvanized products by a least 3 to 1 (for the same coating weight) in many applications.

#### Salt Spray Performance

(hours exposure before appearance of 5% Dark Brown Rust (DBR);

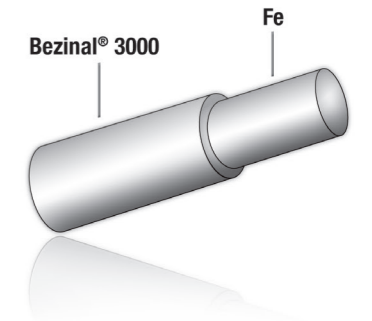

Redrawn wires Bezinal® 3000 Class B according to EN-10244-2

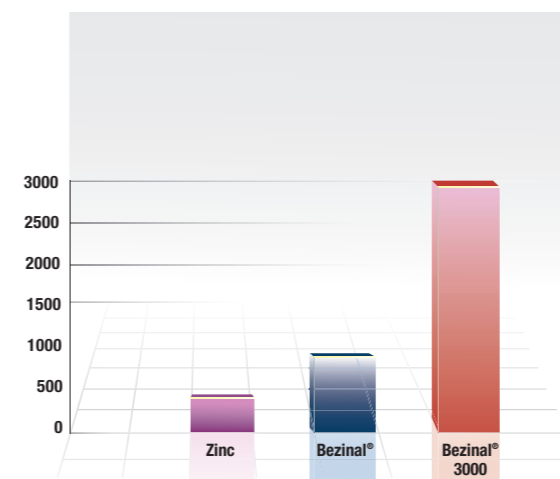

Final coated wires Bezinal® 3000 Class A according to EN-10244-2

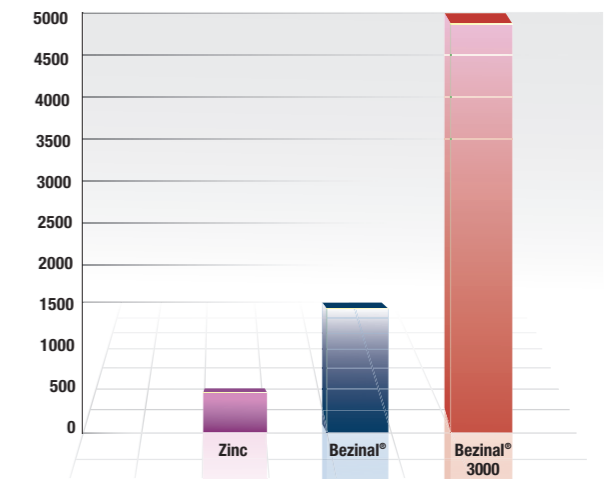

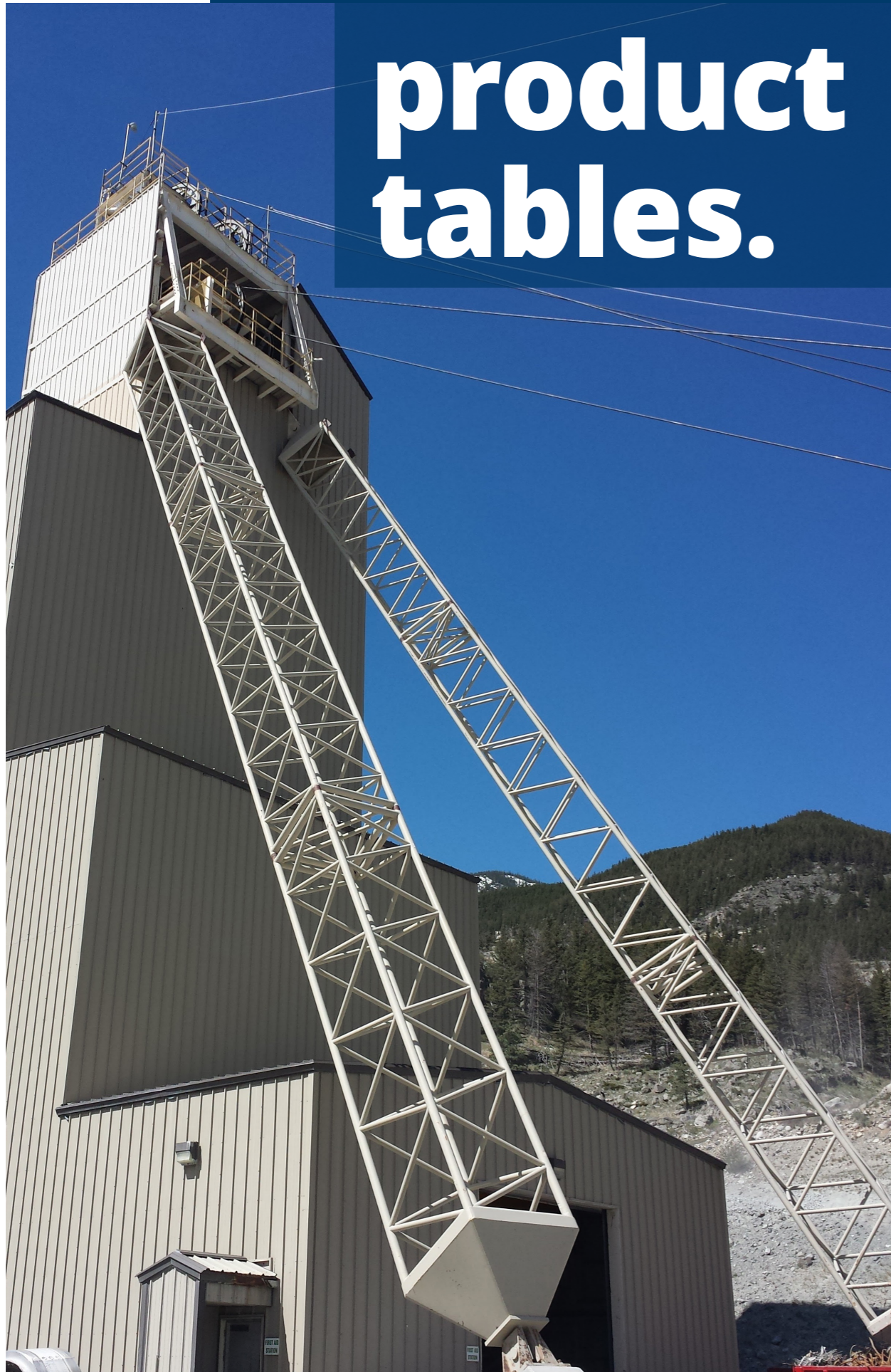

# product tables.



## Tri-MAX FS™

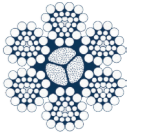

DIAMETER		CONSTRUCTION	APPROX. WEIGHT		MINIMUM BREAKING LOAD							
					115 LTSI / 1770 MPa		125 LTSI / 1960 MPa		133 LTSI / 2060 MPa		140 LTSI / 2160 MPa	
inches	mm		lb/ft	kg/m	lbf	kN	lbf	kN	lbf	kN	lbf	kN
7/8	22	6x27 (3/3) LL Polyester Core	1.4	2.0	71,200	317	77,800	346	82,400	367	86,400	384
1	25	6x27 (3/3) LL Polyester Core	1.8	2.7	94,000	418	102,600	456	108,800	484	115,000	512
1 1/8	29	6x27 (3/3) LL Polyester Core	2.2	3.3	119,800	533	130,200	579	138,400	616	146,400	651
1 1/4	32	6x27 (3/3) LL Polyester Core	2.8	4.1	148,200	659	160,600	714	171,400	762	180,600	803
1 3/8	35	6x27 (3/3) LL Polyester Core	3.4	5.0	179,600	799	194,800	867	207,600	923	215,600	959
1 1/2	38	6x27 (3/3) LL Polyester Core	4.0	6.0	213,800	951	232,800	1,036	247,200	1,100	270,000	1,201
1 5/8	41	6x27 (3/3) LL Polyester Core	4.7	7.0	251,800	1,120	273,600	1,217	291,200	1,295	318,000	1,415
1 3/4	44	6x27 (3/3) LL Polyester Core	5.4	8.0	290,800	1,294	315,400	1,403	336,200	1,496	362,800	1,614
1 7/8	48	6x27 (3/3) LL Polyester Core	6.2	9.2	330,600	1,471	360,000	1,601	382,400	1,701	-	-
2	51	6x27 (3/3) LL Polyester Core	7.0	10.5	374,400	1,665	406,600	1,809	432,800	1,925	-	-
2 1/8	54	6x27 (3/3) LL Polyester Core	7.9	11.7	423,800	1,885	458,800	2,041	487,800	2,170	-	-
2 1/4	57	6x27 (3/3) LL Polyester Core	8.7	12.9	475,000	2,113	513,000	2,282	547,200	2,434	-	-

Note: For 6x25 (6/1) brangle and 6x30 style "G" flattened (triangular) strand ropes, reduce the minimum breaking load by 5%.  
 Whilst every effort has been made to ensure the accuracy of the product tables, the information contained within is intended as a guide. For specific or specialized requirements, please contact our underground mining department to discuss in further detail.

## Tri-Pac FS™

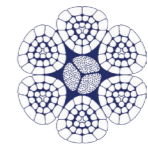

DIAMETER		CONSTRUCTION	APPROX. WEIGHT		MINIMUM BREAKING LOAD					
					115 LTSI / 1770 MPa		125 LTSI / 1960 MPa		133 LTSI / 2060 MPa	
inches	mm		lb/ft	kg/m	lbf	kN	lbf	kN	lbf	kN
7/8	22	6x25 (6/1) Polyester Core	1.51	2.25	80,200	357	86,200	383	91,000	405
1	25	6x25 (6/1) Polyester Core	1.98	2.95	103,600	461	111,400	496	117,600	523
1 1/8	29	6x25 (6/1) Polyester Core	2.50	3.72	133,000	592	143,200	637	151,200	673
1 1/4	32	6x25 (6/1) Polyester Core	3.02	4.49	160,400	714	172,600	768	182,200	810
1 3/8	35	6x25 (6/1) Polyester Core	3.69	5.49	196,800	875	211,600	941	223,600	995
1 1/2	38	6x25 (6/1) Polyester Core	4.36	6.49	232,000	1,032	250,200	1,113	264,200	1,175
1 5/8	41	6x25 (6/1) Polyester Core	5.12	7.62	273,000	1,214	293,600	1,306	310,000	1,379
1 3/4	44	6x25 (6/1) Polyester Core	5.85	8.71	287,600	1,279	309,200	1,375	326,600	1,453
1 7/8	48	6x25 (6/1) Polyester Core	6.72	10.00	362,200	1,611	389,400	1,732	411,200	1,829
2	51	6x25 (6/1) Polyester Core	7.57	11.27	413,600	1,840	444,800	1,979	469,800	2,090

Whilst every effort has been made to ensure the accuracy of the product tables, the information contained within is intended as a guide. For specific or specialized requirements, please contact our underground mining department to discuss in further detail.



# Cushion 34

## Balance Ropes

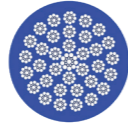

DIAMETER		CONSTRUCTION	APPROX. WEIGHT		MINIMUM BREAKING LOAD	
inches	mm		lb/ft	kg/m	Tons	kN
1	25	34 Strand Cushion Balance Ropes	1.7	2.5	68,000	302
1 1/8	28	34 Strand Cushion Balance Ropes	2.1	3.1	85,400	380
1 1/4	32	34 Strand Cushion Balance Ropes	2.6	3.9	106,600	474
1 3/8	35	34 Strand Cushion Balance Ropes	3.4	5.0	129,800	577
1 1/2	38	34 Strand Cushion Balance Ropes	3.9	5.8	155,400	691
1 5/8	42	34 Strand Cushion Balance Ropes	4.5	6.7	180,800	804
1 3/4	44	34 Strand Cushion Balance Ropes	5.4	8.1	206,600	919
1 7/8	48	34 Strand Cushion Balance Ropes	6.5	9.7	236,000	1050
2	50	34 Strand Cushion Balance Ropes	6.9	10.3	269,400	1198
2 1/8	54	34 Strand Cushion Balance Ropes	7.4	11.0	304000.0	1352
2 1/4	57	34 Strand Cushion Balance Ropes	8.9	13.2	342000.0	1521
2 3/8	60	34 Strand Cushion Balance Ropes	10.0	14.9	380000.0	1690
2 1/2	64	34 Strand Cushion Balance Ropes	10.7	15.9	422000.0	1877

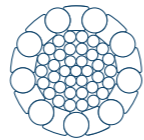

# Power-Loc HLC

DIAMETER		ROPE CONSTRUCTION	APPROX. WEIGHT		MINIMUM BREAKING LOAD	
inches	mm		lb/ft	kg/m	Tons	kN
1 1/2	38	Power-Loc HLC	5.4	8.0	182,200	810
1 5/8	42	Power-Loc HLC	6.5	9.6	219,400	976
1 3/4	44	Power-Loc HLC	7.5	11.1	250,800	1,116
1 7/8	48	Power-Loc HLC	8.6	12.7	287,000	1,277
2	50	Power-Loc HLC	9.7	14.5	328,800	1,463

\*Diameters in table include plastic jacket. Steel rope diameter approx 1/8in or 3mm smaller.

Whilst every effort has been made to ensure the accuracy of the product tables, the information contained within is intended as a guide. For specific or specialized requirements, please contact our underground mining department to discuss in further detail.



# Power-Loc FLC

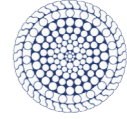

DIAMETER		ROPE CONSTRUCTION	APPROX. WEIGHT		MINIMUM BREAKING LOAD	
inches	mm		lb/ft	kg/m	Tons	kN
1 1/16	17	Power-Loc FLC	1.2	1.8	55,200	491,257
3/4	19	Power-Loc FLC	1.4	2.0	66,000	587,372
13/16	21	Power-Loc FLC	1.6	2.4	76,600	681,707
7/8	22	Power-Loc FLC	1.9	2.8	89,400	795,622
15/16	24	Power-Loc FLC	2.1	3.2	102,200	909,536
1	25	Power-Loc FLC	2.5	3.6	117,200	1,043,030
1 1/16	27	Power-Loc FLC	2.8	4.1	131,200	1,167,624
1 1/8	28	Power-Loc FLC	3.1	4.6	148,200	1,318,917
1 3/16	30	Power-Loc FLC	3.4	5.1	165,400	1,471,990
1 1/4	32	Power-Loc FLC	3.8	5.6	182,400	1,623,282
1 5/16	33	Power-Loc FLC	4.1	6.1	201,400	1,792,374
1 3/8	35	Power-Loc FLC	4.5	6.7	220,400	1,961,466
1 7/16	37	Power-Loc FLC	5.0	7.4	241,400	2,148,357
1 1/2	38	Power-Loc FLC	5.4	8.0	262,200	2,333,468
1 9/16	40	Power-Loc FLC	5.7	8.5	285,000	2,536,379
1 5/8	42	Power-Loc FLC	6.2	9.3	307,800	2,739,289
1 11/16	43	Power-Loc FLC	6.8	10.0	332,600	2,959,998
1 3/4	44	Power-Loc FLC	7.3	10.8	357,200	3,178,928
1 13/16	46	Power-Loc FLC	7.8	11.7	383,800	3,415,656
1 7/8	48	Power-Loc FLC	8.5	12.6	410,400	3,652,385
1 15/16	49	Power-Loc FLC	9.1	13.5	439,000	3,906,913
2	51	Power-Loc FLC	9.7	14.4	467,400	4,159,661
2 1/8	54	Power-Loc FLC	10.9	16.2	527,820	4,697,373

Whilst every effort has been made to ensure the accuracy of the product tables, the information contained within is intended as a guide. For specific or specialized requirements, please contact our underground mining department to discuss in further detail.



# Dy-Pac 34

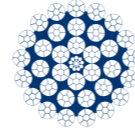

DIAMETER		CONSTRUCTION	APPROX. WEIGHT		MINIMUM BREAKING LOAD					
inches	mm		lb/ft	kg/m	115 LTSI / 1770 MPa		125 LTSI / 1960 MPa		133 LTSI / 2060 MPa	
					lbf	kN	lbf	kN	lbf	kN
1	25	34x7 Dy-Pac Multistrand Hoist Rope	2.1	3.1	106,000	472	116,000	516	122,000	543
1 1/8	28	34x7 Dy-Pac Multistrand Hoist Rope	2.7	4.0	136,000	605	148,000	658	158,000	703
1 1/4	32	34x7 Dy-Pac Multistrand Hoist Rope	3.3	5.0	170,000	756	184,000	819	196,000	872
1 3/8	35	34x7 Dy-Pac Multistrand Hoist Rope	4.1	6.1	204,000	907	224,000	996	236,000	1050
1 1/2	38	34x7 Dy-Pac Multistrand Hoist Rope	4.8	7.1	244,000	1085	266,000	1183	282,000	1254
1 5/8	42	34x7 Dy-Pac Multistrand Hoist Rope	5.6	8.3	286,000	1272	314,000	1397	332,000	1477
1 3/4	44	34x7 Dy-Pac Multistrand Hoist Rope	6.6	9.8	336,000	1495	364,000	1619	388,000	1726
1 7/8	48	34x7 Dy-Pac Multistrand Hoist Rope	7.5	11.1	382,000	1699	414,000	1842	442,000	1966
2	50	34x7 Dy-Pac Multistrand Hoist Rope	8.5	12.6	434,000	1931	472,000	2100	502,000	2233
2 1/8	54	34x7 Dy-Pac Multistrand Hoist Rope	9.5	14.1	478,000	2126	514,000	2286	548,000	2438
2 1/4	57	34x7 Dy-Pac Multistrand Hoist Rope	10.7	15.9	548,000	2438	594,000	2642	632,000	2811

Whilst every effort has been made to ensure the accuracy of the product tables, the information contained within is intended as a guide. For specific or specialized requirements, please contact our underground mining department to discuss in further detail.

# PS 620

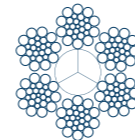

DIAMETER		ROPE CONSTRUCTION	APPROX. WEIGHT		MINIMUM BREAKING LOAD			
inches	mm		lb/ft	kg/m	Gr 115		Gr 125	
					Tons	kN	Tons	kN
5/8	16	6x19 RLL Polyester Core	0.65	0.97	16.0	142	17.4	155
3/4	19	6x19 RLL Polyester Core	0.92	1.37	22.5	200	24.5	218
7/8	22	6x19 RLL Polyester Core	1.24	1.85	30.2	269	32.9	293
1	25	6x19 RLL Polyester Core	1.60	2.38	39.0	348	42.5	378
1 1/8	29	6x19 RLL Polyester Core	2.15	3.20	52.5	468	57.1	508
1 1/4	32	6x19 RLL Polyester Core	2.62	3.90	64.0	570	69.6	620
1 3/8	35	6x19 RLL Polyester Core	3.14	4.67	76.6	681	83.2	741
1 1/2	38	6x19 RLL Polyester Core	3.70	5.51	90.3	803	98.1	873
1 5/8	41	6x19 RLL Polyester Core	4.30	6.40	105.1	935	114.2	1,016
1 3/4	44	6x19 RLL Polyester Core	4.96	7.38	121.0	1,077	131.6	1,171

Whilst every effort has been made to ensure the accuracy of the product tables, the information contained within is intended as a guide. For specific or specialized requirements, please contact our underground mining department to discuss in further detail.



# Cushion-Pac 35

## High Breaking Load

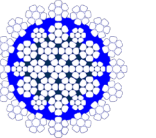

DIAMETER		CONSTRUCTION	APPROX. WEIGHT	MINIMUM BREAKING LOAD			
				1770 MPa	1960 MPa	2060 MPa	2160 MPa
mm			kg/m	kN	kN	kN	kN
28		Cushion-Pac 35 HBL	3.8	614	676	721	<b>756</b>
32		Cushion-Pac 35 HBL	4.7	747	801	863	<b>907</b>
35		Cushion-Pac 35 HBL	5.7	916	1005	1068	<b>1130</b>
38		Cushion-Pac 35 HBL	7.3	1121	1228	1317	<b>1388</b>
42		Cushion-Pac 35 HBL	8.6	1281	1406	1504	<b>1584</b>
44		Cushion-Pac 35 HBL	10.3	1566	1717	1833	<b>1931</b>
48		Cushion-Pac 35 HBL	11.8	1717	1859	1984	<b>2073</b>
50		Cushion-Pac 35 HBL	13.4	2011	2206	2349	<b>2482</b>
54		Cushion-Pac 35 HBL	14.6	2260	2473	2642	-
57		Cushion-Pac 35 HBL	15.8	2375	2607	2785	-

DIAMETER		CONSTRUCTION	APPROX. WEIGHT	MINIMUM BREAKING LOAD			
inches				lb/ft	Gr 115	Gr 125	Gr 140
			lb/ft	lbf	lbf	lbf	lbf
1 1/8		Cushion-Pac 35 HBL	2.1	138,000	152,000	162,000	170,000
1 1/4		Cushion-Pac 35 HBL	2.7	168,000	180,000	194,000	204,000
1 3/8		Cushion-Pac 35 HBL	3.3	206,000	226,000	240,000	254,000
1 1/2		Cushion-Pac 35 HBL	4.0	252,000	276,000	296,000	312,000
1 5/8		Cushion-Pac 35 HBL	4.8	288,000	316,000	338,000	356,000
1 3/4		Cushion-Pac 35 HBL	5.6	352,000	386,000	412,000	434,000
1 7/8		Cushion-Pac 35 HBL	6.5	386,000	418,000	446,000	466,000
2		Cushion-Pac 35 HBL	7.5	452,000	496,000	528,000	558,000
2 1/8		Cushion-Pac 35 HBL	8.5	508,000	556,000	594,000	-
2 1/4		Cushion-Pac 35 HBL	9.6	534,000	586,000	626,000	-

Whilst every effort has been made to ensure the accuracy of the product tables, the information contained within is intended as a guide. For specific or specialized requirements, please contact our underground mining department to discuss in further detail.

Available in different breaking loads

\*Bezinal Also available



# Cushion-Pac 35

Low Weight

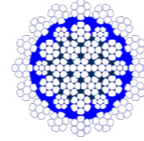

DIAMETER	CONSTRUCTION	APPROX. WEIGHT	MINIMUM BREAKING LOAD			
			1770 MPa	1960 MPa	2060 MPa	2160 MPa
mm		kg/m	kN	kN	kN	676
28	Cushion-Pac 35 Low Weight	3.60	543	596	641	<b>827</b>
32	Cushion-Pac 35 Low Weight	4.55	676	738	792	<b>979</b>
35	Cushion-Pac 35 Low Weight	5.45	810	872	934	<b>1125</b>
38	Cushion-Pac 35 Low Weight	6.29	970	996	1068	<b>1432</b>
42	Cushion-Pac 35 Low Weight	7.80	1165	1272	1361	<b>1601</b>
44	Cushion-Pac 35 Low Weight	8.72	1317	1423	1521	<b>1833</b>
48	Cushion-Pac 35 Low Weight	9.81	1486	1637	1744	<b>2162</b>
50	Cushion-Pac 35 Low Weight	11.26	1753	1913	2046	-
54	Cushion-Pac 35 Low Weight	12.69	2020	2215	2367	-
57	Cushion-Pac 35 Low Weight	14.11	2269	2518	2696	-

DIAMETER	CONSTRUCTION	APPROX. WEIGHT	MINIMUM BREAKING LOAD			
			Gr 115	Gr 125	Gr 133	Gr140
inches		lb/ft	lbf	lbf	lbf	lbf
1 1/8	Cushion-Pac 35 Low Weight	2.42	122000	52.7	58.6	152000
1 1/4	Cushion-Pac 35 Low Weight	3.06	152,000	66.7	74.1	186,000
1 3/8	Cushion-Pac 35 Low Weight	3.66	182000	82.4	91.5	220000
1 1/2	Cushion-Pac 35 Low Weight	4.23	218000	100	111	253000
1 5/8	Cushion-Pac 35 Low Weight	5.24	262000	119	132	322000
1 3/4	Cushion-Pac 35 Low Weight	5.86	296000	139	155	360000
1 7/8	Cushion-Pac 35 Low Weight	6.59	334000	162	179	412000
2	Cushion-Pac 35 Low Weight	7.57	394000	185	206	486000
2 1/8	Cushion-Pac 35 Low Weight	8.53	454000	211	234	-
2 1/4	Cushion-Pac 35 Low Weight	9.48	510000	238	264	-

Whilst every effort has been made to ensure the accuracy of the product tables, the information contained within is intended as a guide. For specific or specialized requirements, please contact our underground mining department to discuss in further detail.



# PS 1810

Shaft Sinking

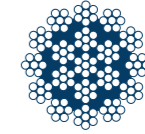

DIAMETER	CONSTRUCTION	APPROX. WEIGHT	MINIMUM BREAKING LOAD					
			115 LTSI / 1770 Mpa		125 LTSI / 1960 Mpa			
inches	mm	lb/ft	kg/m	lbf	kN	lbf	kN	
3/4	19	18x7 RLL LCD IWRC	1.0	1.5	50,200	223	54,200	241
7/8	22	18x7 RLL LCD IWRC	1.4	2.0	66,000	294	71,400	318
1	25	18x7 RLL LCD IWRC	1.8	2.6	86,000	383	94,600	421
1 1/8	28	18x7 RLL LCD IWRC	2.2	3.3	110,000	489	117,600	523
1 1/4	32	18x7 RLL LCD IWRC	2.8	4.2	134,200	597	145,000	645
1 3/8	35	18x7 RLL LCD IWRC	3.4	5.0	163,400	727	176,800	786
1 1/2	38	18x7 RLL LCD IWRC	4.0	5.9	193,400	860	209,200	931

Whilst every effort has been made to ensure the accuracy of the product tables, the information contained within is intended as a guide. For specific or specialized requirements, please contact our underground mining department to discuss in further detail.

# PS 1810

Balance Ropes

DIAMETER	CONSTRUCTION	APPROX. WEIGHT	MINIMUM BREAKING LOAD			
			100 LTSI / 1570 MPa			
inches	mm	lb/ft	kg/m	Tons	kN	
3/4	19	18x7 Round Multistrand Balance Rope	0.94	1.40	39,800	177
7/8	22	18x7 Round Multistrand Balance Rope	1.27	1.89	53,400	238
1	25	18x7 Round Multistrand Balance Rope	1.64	2.44	69,400	309
1 1/8	28	18x7 Round Multistrand Balance Rope	2.07	3.08	89,300	397
1 1/4	32	18x7 Round Multistrand Balance Rope	2.56	3.81	110,200	490
1 3/8	35	18x7 Round Multistrand Balance Rope	3.10	4.61	133,000	592
1 1/2	38	18x7 Round Multistrand Balance Rope	3.69	5.49	158,650	706
1 5/8	42	18x7 Round Multistrand Balance Rope	4.33	6.44	186,200	828
1 3/4	44	18x7 Round Multistrand Balance Rope	5.02	7.47	215,650	959
1 7/8	48	18x7 Round Multistrand Balance Rope	5.76	8.57	247,950	1,103

Whilst every effort has been made to ensure the accuracy of the product tables, the information contained within is intended as a guide. For specific or specialized requirements, please contact our underground mining department to discuss in further detail.

# PS 3410

## Shaft Sinking

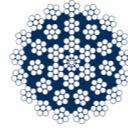

DIAMETER		CONSTRUCTION	APPROX. WEIGHT		MINIMUM BREAKING LOAD					
inches	mm		lb/ft	kg/m	115 LTSI / 1770 MPa		125 LTSI / 1960 MPa		133 LTSI / 2060 MPa	
					lbf	kN	lbf	kN	lbf	kN
1	25	34x7 Round Multistrand Hoist Rope	1.8	2.7	88,400	393	96,200	428	105,000	467
1 1/8	28	34x7 Round Multistrand Hoist Rope	2.4	3.5	116,000	516	126,000	560	135,200	601
1 1/4	32	34x7 Round Multistrand Hoist Rope	2.8	4.2	141,400	629	153,400	682	163,200	726
1 3/8	35	34x7 Round Multistrand Hoist Rope	3.4	5.1	167,200	744	182,200	810	193,400	860
1 1/2	38	34x7 Round Multistrand Hoist Rope	4.1	6.0	199,000	885	216,000	961	230,000	1023
1 5/8	42	34x7 Round Multistrand Hoist Rope	4.8	7.1	234,000	1041	254,000	1130	270,000	1201
1 3/4	44	34x7 Round Multistrand Hoist Rope	5.5	8.2	274,000	1219	298,000	1326	314,000	1397
1 7/8	48	34x7 Round Multistrand Hoist Rope	6.3	9.4	314,000	1397	340,000	1512	364,000	1619
2	50	34x7 Round Multistrand Hoist Rope	7.2	10.7	368,000	1637	398,000	1770	422,000	1877
2 1/8	54	34x7 Round Multistrand Hoist Rope	8.1	12.1	414,000	1842	448,000	1993	476,000	2117
2 1/4	57	34x7 Round Multistrand Hoist Rope	9.1	13.6	464,000	2064	500,000	2224	530,000	2358
2 3/8	60	34x7 Round Multistrand Hoist Rope	10.2	15.1	516,000	2295	556,000	2473	590,000	2625
2 1/2	64	34x7 Round Multistrand Hoist Rope	11.3	16.8	570,000	2536	616,000	2740	654,000	2909

Whilst every effort has been made to ensure the accuracy of the product tables, the information contained within is intended as a guide. For specific or specialized requirements, please contact our underground mining department to discuss in further detail.

# PS 3410

## Balance Ropes

DIAMETER		CONSTRUCTION	APPROX. WEIGHT		MINIMUM BREAKING LOAD	
inches	mm		lb/ft	kg/m	100 LTSI / 1570 MPa	
				lbf	kN	
1	25	34 Strand Cushion Balance Ropes	1.7	2.5	68,000	302
1 1/8	28	34 Strand Cushion Balance Ropes	2.1	3.1	85,400	380
1 1/4	32	34 Strand Cushion Balance Ropes	2.6	3.9	106,600	474
1 3/8	35	34 Strand Cushion Balance Ropes	3.4	5.0	129,800	577
1 1/2	38	34 Strand Cushion Balance Ropes	3.9	5.8	155,400	691
1 5/8	42	34 Strand Cushion Balance Ropes	4.5	6.7	180,800	804
1 3/4	44	34 Strand Cushion Balance Ropes	5.4	8.1	206,600	919
1 7/8	48	34 Strand Cushion Balance Ropes	6.5	9.7	236,000	1050
2	50	34 Strand Cushion Balance Ropes	6.9	10.3	269,400	1198
2 1/8	54	34 Strand Cushion Balance Ropes	7.4	11.0	304000.0	1352
2 1/4	57	34 Strand Cushion Balance Ropes	8.9	13.2	342000.0	1521
2 3/8	60	34 Strand Cushion Balance Ropes	10.0	14.9	380000.0	1690
2 1/2	64	34 Strand Cushion Balance Ropes	10.7	15.9	422000.0	1877

Whilst every effort has been made to ensure the accuracy of the product tables, the information contained within is intended as a guide. For specific or specialized requirements, please contact our underground mining department to discuss in further detail.

# Zebra®

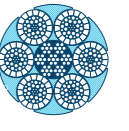

Nominal Diameter	Nominal Length Mass	Calculated Minimum Breaking Load			
		Grade 1670 N/mm <sup>2</sup>	Grade 1670 N/mm <sup>2</sup>	Grade 1820 N/mm <sup>2</sup>	Grade 1820 N/mm <sup>2</sup>
mm	kg/m	tonnes	kN	tonnes	kN
<b>6x19S</b>					
32	3.94	59.51	584	64.40	632
33	4.19	63.28	621	68.48	672
34	4.45	67.18	659	72.70	713
35	4.71	71.19	698	77.04	756
36	4.99	75.31	739	81.50	800
37	5.27	79.56	780	86.09	845
38	5.56	83.91	823	90.81	891
39	5.85	88.39	867	95.65	938
40	6.16	92.98	912	100.62	987
41	6.47	97.69	958	105.71	1037
<b>6x26WS</b>					
41	6.51	98.25	964	106.33	1043
42	6.83	103.10	1011	111.58	1095
43	7.16	108.07	1060	116.95	1147
44	7.49	113.16	1110	122.46	1201
45	7.84	118.36	1161	128.09	1257
46	8.53	127.20	1248	137.65	1350
47	8.91	132.79	1303	143.70	1410
48	9.29	138.50	1359	149.88	1470
49	9.68	144.33	1416	156.19	1532
50	10.08	150.28	1474	162.63	1595
51	10.49	156.35	1534	169.20	1660
52	10.90	162.54	1595	175.90	1726
<b>6x31WS</b>					
41	6.69	100.97	991	109.28	1072
42	7.02	105.95	1039	114.68	1125
43	7.36	111.06	1089	120.21	1179
44	7.70	116.28	1141	125.86	1235
45	8.06	121.63	1193	131.65	1291
46	8.77	130.71	1282	141.48	1388
47	9.15	136.45	1339	147.70	1449
48	9.55	142.32	1396	154.05	1511
49	9.95	148.32	1455	160.54	1575
50	10.36	154.43	1515	167.15	1640
51	10.78	160.67	1576	173.91	1706
52	11.21	167.03	1639	180.79	1774
53	11.64	173.52	1702	187.82	1843
54	12.08	180.13	1767	194.97	1913
55	12.54	186.86	1833	202.26	1984
56	13.00	193.72	1900	209.68	2057
57	13.46	200.80	1969	217.23	2131
58	13.94	207.80	2039	224.92	2206
59	14.43	215.03	2109	232.75	2283
60	13.88	222.38	2182	240.70	2361

Whilst every effort has been made to ensure the accuracy of the product tables, the information contained within is intended as a guide. For specific or specialized requirements, please contact our underground mining department to discuss in further detail.

## Dyform 24LS

Hoist Rope

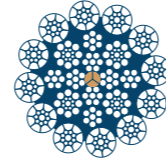

Nominal Diameter	Approx. Mass	Calculated Aggregate Breaking Force					Calculated Minimum Breaking Force				
		1570 N/mm <sup>2</sup>	1770 N/mm <sup>2</sup>	1860 N/mm <sup>2</sup>	1960 N/mm <sup>2</sup>	2060 N/mm <sup>2</sup>	1570 N/mm <sup>2</sup>	1770 N/mm <sup>2</sup>	1860 N/mm <sup>2</sup>	1960 N/mm <sup>2</sup>	2060 N/mm <sup>2</sup>
mm	kg/m	kN	kN	kN	kN	kN	kN	kN	kN	kN	kN
24	2.74	481	543	570	601	632	375	423	445	469	493
25	2.97	522	589	619	652	685	407	459	483	509	535
26	3.21	565	637	669	705	741	441	497	522	550	578
27	3.46	609	687	722	761	800	475	536	563	593	624
28	3.73	655	739	776	818	860	511	576	606	638	671
29	4.00	703	793	833	878	923	548	618	650	685	719
30	4.27	752	848	891	939	987	587	662	695	733	770
31	4.56	803	906	952	1000	1050	627	706	742	782	822
32	4.86	856	965	1010	1060	1120	668	753	791	834	876
33	5.17	910	1020	1070	1130	1190	710	801	841	887	932
34	5.49	967	1090	1140	1200	1260	754	850	893	941	989
35	5.82	1020	1150	1210	1270	1340	799	901	946	997	1040
36	6.16	1080	1220	1280	1350	1420	845	953	1000	1050	1100
37	6.50	1140	1290	1350	1420	1500	893	1000	1050	1110	1170
38	6.86	1200	1360	1430	1500	1580	942	1060	1110	1170	1230
39	7.22	1270	1430	1500	1580	1660	992	1110	1170	1230	1300
40	7.60	1330	1500	1580	1670	1750	1040	1170	1230	1300	1360
41	7.98	1400	1580	1660	1750	1840	1090	1230	1290	1360	1430
42	8.37	1470	1660	1740	1840	1930	1150	1290	1360	1430	1510
43	8.79	1540	1740	1830	1930	2020	1200	1360	1420	1500	1580
44	9.20	1610	1820	1910	2020	2120	1260	1420	1490	1570	1650
45	9.62	1690	1900	2000	2110	2220	1320	1480	1560	1640	1730
46	10.10	1770	1990	2090	2200	2320	1380	1550	1630	1720	1810
47	10.50	1840	2080	2180	2300	2420	1440	1620	1700	1790	1890
48	10.90	1920	2170	2280	2400	2520	1500	1690	1780	1870	1970
49	11.40	2000	2260	2370	2500	2630	1560	1760	1850	1950	2050
50	11.90	2090	2350	2470	2600	2740	1630	1830	1930	2030	2130
51	12.30	2170	2450	2570	2710	2850	1690	1910	2000	2110	2220
52	12.80	2260	2540	2670	2820	2960	1760	1980	2080	2200	2310
53	13.30	2340	2640	2780	2930	3080	1830	2060	2170	2280	2400
54	13.90	2430	2740	2880	3040	3190	1900	2140	2250	2370	2490
55	14.40	2520	2850	2990	3150	3310	1970	2220	2330	2460	2580
56	14.90	2620	2950	3100	3270	3440	2040	2300	2420	2550	2680
57	15.40	2710	3060	3210	3390	3560	2110	2380	2510	2640	2780
58	16.00	2810	3170	3330	3510	3690	2190	2470	2590	2730	2870
59	16.50	2910	3280	3440	3630		2270	2550	2680	2830	
60	17.10	3010	3390	3560	3750		2340	2640	2780	2930	
61	17.70	3110	3500	3680	3880		2420	2730	2870	3020	
62	18.30	3210	3620	3800	4010		2500	2820	2970	3130	
63	18.80	3310	3740	3930	4140		2580	2910	3060	3230	
64	19.50	3420	3860	4050	4270		2670	3010	3160	3330	
65	20.10	3530	3980	4180	4410		2750	3100	3260	3440	

Whilst every effort has been made to ensure the accuracy of the product tables, the information contained within is intended as a guide. For specific or specialized requirements, please contact our underground mining department to discuss in further detail.

# technical information.



# 1. Hoist Ropes

Various constructions of ropes may be used for hoisting, the final choice usually being decided upon economic grounds. What may be a satisfactory life on a shallow high frequency hoist, may be completely uneconomic on a deep low frequency installation, and therefore the rope designs as well as their sizes must be considered.

## 1.1 Drum Hoists

6 Stranded Ropes – both round and triangular strand – are satisfactory for all depths of shafts, although perhaps best suited for those up to 1000m in depth with fixed guides. They are not suitable for shafts deeper than 600m with rope guides, as their natural tendency to twist causes the conveyance to turn.

As a rough guide to the construction of the rope, the ratio of drum or sheave diameter to outer wire diameter should be between 1000 and 1500:1, although if abrasion is severe this can be reduced slightly at the expense of a lower fatigue life.

For maximum resistance to wear and crossover damage the use of Lang's lay is recommended.

Multi-Strand Rotation Resistant Ropes – are now used on permanent drum hoist installations, except where multi-layer coiling is employed, due to their relatively low resistance to compressive forces. Certain constructions are suitable for sinking purposes.

Multi-strand ropes with Dyformed (compacted) strands have increased resistance to crushing over ropes with conventional strands.

Locked Coil Ropes – have gained in popularity and are extensively used throughout the UK. They can be used to advantage on any depth of shaft with either fixed or rope guides. As they are virtually non-rotating under normal loading conditions they are considered to be the best rope to operate in shafts deeper than 700 metres equipped with rope guides.

The cross section is extremely compact and as a result such ropes can withstand very high radial and compressive forces. This property coupled with their smooth outer surface enables them to be used to advantage on multi-layer coiling installations.

Because of their compact cross section, it is desirable that the drum or sheave diameter to rope diameter ratio should be in the region of 100 to 120:1 for satisfactory service life on main shaft winders and for kibble ropes used in shaft sinking. Ratios as low as 50:1 can be tolerated on small ropes in shallow shafts, staple shafts and sinking stage winders.

## 1.2 Friction or Koepe Hoists

6 Stranded Ropes – are suitable to depths of 1000 metres. Beyond that the torque in these ropes can result in premature torsional fatigue of the wires. Triangular strands are more suited due to the lower contact pressures on the friction linings although Lang's lay equal laid round strand ropes are quite suitable for shallow shafts. Round strand ropes with Dyformed (compacted) strands are becoming more popular as they offer higher breaking loads, increased fatigue life and reduced contact pressures over ropes with conventional strands.

With rope guided shafts, alternate left and right hand lay ropes are employed to prevent conveyance twist.

Tread pressures with stranded ropes are limited to 17.5 kgf/cm<sup>2</sup> (1.72Mpa) to avoid excessive wear of the friction linings.

Multi-Strand Rotation Resistant Ropes – can be usefully employed at all depths of shaft and generally satisfactory lives are obtained. Earlier designs of the ropes were subject to severe internal cross-cutting. However modern designs incorporating Dyformed (compacted) strands and plastic enhancement coupled with modern manufacturing techniques.

Tread pressure limits are similar to those of 6 stranded ropes.

Locked Coil Ropes – are widely used on this type of hoist particularly in the UK. The advantages offered by ropes of this construction make them particularly suited for this type of hoist especially if rope guides are employed.

Due to the large smooth surface area of locked coil ropes, tread pressures of up to 28.0 kgf/cm<sup>2</sup> (2.75MPa) can be tolerated. The limit is used to minimise friction liner wear, the rope being able to withstand much higher pressures.

## 1.3 Recommended Rope Constructions for various winder applications

Type of winder application	Rope Construction
Small drum hoist operating at less than 2.5m/s in a vertical shaft with fixed guides	6x19(9/9/1) FC Langs Lay Full Locked Coil
Small Drum hoist operating in a vertical shaft with rope guides	Multi-strand Rotation Resistant Full Locked Coil
Large drum hoist operating in a vertical shaft with fixed guides	Compound Triangular Strand Langs Lay Full Locked Coil Dyform 6R Ordinary/Langs Lay
Large drum hoist operating in a vertical shaft with rope guides	Multi-strand Rotation Resistant Full Locked Coil
Blair multi-rope hoist	Compound Triangular Strand Langs Lay Full Locked Coil
Friction hoist operating to a depth of 500m	6 strand Ordinary/Langs Lay Compound Triangular Strand Langs Lay Multi-strand Rotation Resistant Full Locked Coil Dyform 6R Ordinary/Langs Lay
Friction hoist operating to a depth between 500m and 1000m	6 Strand Ordinary/Langs Lay Compound Triangular Strand Langs Lay Multi-strand Rotation Resistant Full Locked Coil Dyform 6R Ordinary/Langs Lay
Friction Hoists above 1000m	Locked Coil Winding Ropes Multi-strand Rotation Resistant Dyform 6R Ordinary/Langs Lay Compound Triangular Strand Langs Lay
Sinking stage winder	Multi-strand Rotation Resistant Full Locked Coil Alternate Lay Triangular Strand Langs Lay
Kibble winder	Multi-strand Rotation Resistant Full Locked Coil  Multi-strand Rotation Resistant Superflex Flat rope

# 2. Sinking Ropes

Kibble Ropes – Ropes used for these duties must be rotation resistant, to prevent excessive spin of the kibble or bucket in the shaft.

Providing the hoist equipment is suitable, flexible full locked coil ropes meet these requirements admirably, and have been used successfully for many years. Where very small diameter sinking drums and sheaves are employed, or where a sheave is fitted above the kibble to enable two parts of rope to support the load, multi-strand rotation resistant ropes are recommended.

Bridon's dedicated Mining Department will be pleased to discuss and recommend the best rope construction for optimum performance on your kibble winder.

Stage Ropes – There are several methods of suspending the sinking stage or platform and this can govern the choice of rope construction.

Stage ropes are normally required to act as guide ropes for the kibble, so resistance to wear is a necessary characteristic. In addition, a good resistance to crushing on multi-layer drum coiling is required.

Full locked coil ropes offer excellent performance on the correct design of equipment.

Where smaller drums and sheaves are employed multi-strand rotation resistant ropes with relatively large outer wires or triangular strands with equal numbers of left and right hand lay can be used. With triangular strand ropes however, problems can be experienced with controlling the turn if slack rope conditions occur.

Bridon's dedicated Mining Department will be pleased to discuss and recommend the best rope construction for optimum performance on your stage winder.

Under normal circumstances it is recommended that ropes for both applications, but in particular stage ropes, should be manufactured from galvanised material. However, where higher tensile grades of wire are required galvanised material is not always available. In these cases it is strongly recommended that the ropes are regularly cleaned and re-lubricated with emphasis on the evaluation of corrosion during examination.

### 3. Balance Ropes

Generally balance ropes are required to have the flexibility to suit the particular cage centres, adequate rotation resistant properties combined with good resistance to wear and corrosion. Bridon's range of multi-strand rotation resistant and Flat Balance ropes have the capability to meet the needs for all balance rope applications.

Bridon-Bekaert's Superflex balance ropes were developed for installations where maximum flexibility is required combined with optimum resistance to wear and corrosion. The range of ropes is almost completely non-rotating, however it is common industry practice to also use a swivel within the attachment assembly. As a result there is no torsional effect either at the terminal ends or at the loop and therefore the onset of fatigue at these points is almost entirely eliminated. However it is common industry practice to also incorporate a balance rope swivel within the rope attachment assembly

Where maximum flexibility is not required alternative constructions are available to suit the specific winding conditions and provide optimum service life.

The graph below gives the minimum recommended loop diameter to rope diameter ratio for various constructions.

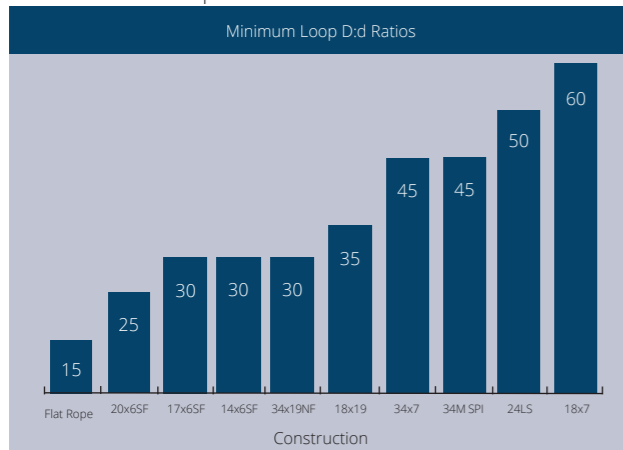

For advice on the best rope for your installations contact Bridon's dedicated Mining Department.

### 4. Guide and Rubbing Ropes

Bridon-Bekaert's Tiger Brand range of guide and rubbing ropes are normally constructed of a central king wire, covered by one or two layers of round wires which are closed in a final layer of half lock and round wires. The precise construction depends upon the diameter and the tensile grade of wires used to meet the breaking force requirement. Bridon's CAD rope design system ensures that the largest possible outer half lock and round wires are used to give maximum resistance to wear and corrosion.

The choice of size and breaking load depends upon the local regulations for factor of safety and the tensioning required. A typical arrangement is a factor of safety of 5:1 at the point of suspension with the guides tensioned on the basis of 3000kg plus 500kg for each 100m of shaft depth. The tensions are normally varied in the range plus or minus 10% to limit harmonic vibration.

In wet and corrosive shafts the use of galvanised material is recommended.

Types of tensioning arrangement, terminations and methods of installation are many and varied, Bridon's dedicated Mining Department will be pleased to give advice on these aspects along with types of layouts, methods of lubrication, inspection procedures and maintenance.

### 5. Haulage Ropes

The modern rope haulage system is an integral part of the system for both the transportation of men and the supply of materials to the mine face.

Haulage systems fall into 3 main categories  
 Endless  
 Direct  
 Main and Tail

Bridon Bekaert's Tiger Brand range has the rope to suit your system.

In general, haulage ropes are required to have excellent resistance to wear and in some instances corrosion. To achieve this they tend to be of the more simple construction with fewer larger outer wires. These can be single layer round strand construction or triangular strand construction. On the majority of systems where the length of travel is high and the frequency of cycle is small, fatigue is generally not a critical deteriorating factor.

#### 5.1 Single Construction

Round Strand  
 6x7(6/1) Fibre Core Langs lay is recommended to maximise the resistance to wear.

Triangular Strand  
 6x8TS, 6x9TS, 6x10TS.

However, when travel distances become shorter and the cycle frequency is higher then fatigue can become a factor dictating rope removal, particularly when drive wheels, drums and sheaves are smaller. To combat this, more complex (compound constructions) with smaller outer wires can be used.

#### 5.2 Compound Construction

Round Strand  
 6x7, 6x19(S), Dyform 6x19(S), 6x22(TS).

Triangular Strand  
 6x22TS, 6x23TS, 6x25TS, 6x28TS.

Where wet and corrosive conditions exist the use of

On certain installations where resistance to crushing is required, then the use of ropes with steel IWRC cores should be considered.

On endless systems, ropes with special preforming are supplied to facilitate long splicing.

The performance of round strand ropes can be enhanced by the use of Dyformed strands. Dyform ropes offer the following improvements:-

- Higher breaking loads
- Improved fatigue life
- Increased resistance to crushing
- Reduced interference on drums and Clifton (surge) wheels

Bristar Cores offer the following improvements:-

- Reduced stretch
- Increased fatigue life
- Increased dimension stability (diameter retention)

Contact our dedicated Mining Department for advice on the best construction for your haulage application.

### 6. Conveyor Drive Ropes

Bridon-Bekaert has had a close working relationship with the OEM's of cable driven conveyors for many years. This has resulted in Bridon being the major supplier of cable belt driving ropes world wide. Extensive research and development has resulted in Bridon's Tiger Brand range of driving ropes such that Bridon can offer rope solutions to give optimum lowest cost conveying of material.

The Tiger Brand range offers the following rope options:-

Conventional Driving Ropes  
 6x19S, 6x26WS, 6x25F, 6x31WS, 6x36WS.

The type of construction used depends upon the diameter, stress levels, the type of conveyor and it's layout.

Dyform Driving Ropes  
 6x19S Dyform, 6x26WS Dyform, 6x31WS Dyform, 6x36WS Dyform.

Dyform Driving Ropes offer the following advantages:-

- Higher breaking forces
- Increased fatigue life
- Increased resistance to wear
- Reduced line stand pulley wear during the early part of service life

Driving ropes are generally supplied in galvanised material although ropes manufactured from bright wire are available. They are produced under the highest quality system from high specification wire and cores specially designed and manufactured for use on rope driven conveyors. All ropes have specific strand preformation to facilitate long splicing and maximise splice life.

In both conventional and Dyform drive ropes, alternative cores and manufacturing lubrication are available to best suit your conveyor conditions to ensure maximum economic operating performance. These include the following:-

- Man made fibre cores for use in wet conditions
- Bristar cores offering lower stretch, increased fatigue life and improve diameter retention
- Special lubrication, both manufacturing and service, to ensure maximum life in severe corrosive conditions

Zebra Drive Ropes

Joint development with rope driven conveyor manufacturers and operators has resulted in Bridon's Zebra range of conveyor drive ropes.

Extensive laboratory and on site testing has shown the following advantages of Zebra over conventional and Dyform drive ropes:

- Increased fatigue life. In excess of 10 times conventional cables in laboratory tests
- Equivalent or increased breaking loads
- Reduced stretch both constructional and elastic
- Superior diameter retention
- Smooth outer surface
- Reduced tread pressures
- Superior resistance to internal corrosion

These improvements in physical properties have realised the following proven cost saving advantages:

- Zebra can be retro fitted to existing conveyors at minimal cost
- Reduced line pulley wear
- Reduced steel terminal pulley and surge/Koepe lining maintenance
- Reduced vibration and noise
- Extended rope life
- Extended splice life

For an assessment of potential cost saving on your conveyor contact Bridon directly.

Bridon's commitment to lowest cost conveying doesn't stop there. On long conveyors splicing and splice maintenance can be both inconvenient and costly. Bridon's unique Service Department can provide expert engineers to install, splice, inspect and maintain your drive cables. Driving ropes are a major cost component part of the conveyor. LOOK AFTER THEM !

In addition Bridon-Bekaert recognised the implications of down time and cost of splicing on long conveyors with numerous splices. To minimise splicing and splice repairs Bridon increased its production capacity from piece weights of 60 tonnes to piece weights of approximately 135 tonnes. If you think longer ropes can assist in reducing operating costs contact our Mining Department who will be pleased to discuss the various options.

## 7. Properties of Extension of Steel Wire Ropes

Any assembly of steel wires spun into a helical formation, either as a strand or wire rope, when subjected to a tensile load, can extend in three separate phases, depending on the magnitude of the applied load.

There are also other factors which produce rope extension which are very small and can normally be ignored.

Phase 1 - Initial or Permanent Constructional Extension

At the commencement of loading a new rope, extension is created by the bedding down of the assembled wires with a corresponding reduction in overall diameter. This reduction in diameter creates an excess length of wire which is accommodated by a lengthening of the helical lay. When sufficiently large bearing areas have been generated on adjacent wires to withstand the circumferential compressive loads, this mechanically created extension ceases and the extension in Phase 2 commences. The Initial Extension of any rope cannot be accurately determined by calculation and has no elastic properties.

The practical value of this characteristic depends upon many factors, the most important being the type and construction of rope, the range of loads and the number and frequency of the cycles of operation. It is not possible to quote exact values for the various constructions of rope in use, but the following approximate values may be employed to give reasonably accurate results.

The above figures are for guidance purposes. More precise figures are available upon request.

Locked Coil Hoist Ropes

	% of rope length	
	Fibre Core	Steel Core
Lightly loaded Factor of safety about 8:1	0.25	0.125
Normally loaded Factor of safety about 5:1	0.50	0.25
Heavily loaded Factor of safety about 3:1	0.75	0.50
Heavily loaded with many bends and/or deflections	Up to 2.00	Up to 1.00

Immediate permanent extension	0.08
Additional initial extension	0.08
Gradual permanent extension	0.08
Total extension approx.	0.25

Phase 2 - Elastic Extension

Following Phase 1, the rope extends in a manner which complies approximately with Hooke's Law (stress is proportional to strain) until the Limit of Proportionality or Elastic Limit is reached.

It is important to note that wire ropes do not possess a Young's Modulus of Elasticity, however an 'apparent' Modulus of Elasticity can be

determined between two fixed loads.

The Modulus of Elasticity also varies with different rope constructions, but generally increases as the cross-sectional area of steel increases. By using the values given, it is possible to make a reasonable estimate of elastic extension, but if greater accuracy is required it is advisable to carry out a modulus test on an actual sample of the rope. As rope users will find it difficult to calculate the actual metallic steel area, the values normally quoted are based on the circumscribed rope area (area of a circle, related to the nominal diameter of the rope).

$$\text{Elastic Extension} = \frac{WL}{EA} \text{ (mm)}$$

W = load applied (kgs)

L = rope length (mm)

E = elastic modulus (kg/mm<sup>2</sup>)

A = circumscribed rope area (mm<sup>2</sup>)

Phase 3 - Permanent Extension

The permanent, non-elastic extension of the steel caused by tensile loads exceeding the yield point of the material.

If the load exceeds the Limit of Proportionality, the rate of extension will accelerate as the load is increased, until a loading is reached at which continuous extension will commence, causing the wire rope to fracture without any further increase of load.

Thermal Expansion and Contraction

The coefficient of linear expansion ( $\alpha$ ) of steel wire rope is 0.0000125 = (12.5 x 10<sup>-6</sup>) per °C, therefore the change in length of 1 metre of rope produced by a temperature change of t °C would be;

$$\text{Change in length } \Delta l = \alpha \cdot l \cdot t \text{ where}$$

$\alpha$  = coefficient of linear expansion

$l$  = original length of rope (m)

$t$  = temperature change (°C)

The change will be an increase in length if the temperature rises and a decrease in length if the temperature falls.

Extension due to Rotation

The elongation caused by a free rope end being allowed to rotate.

Extension due to Wear

The elongation due to inter-wire wear which reduces the cross-sectional area of steel and produces extra constructional extension.

Example: What will be the total elongation of a 200 metre length of 28mm diameter Tiger 6R wire rope at a tension of 10 tonnesf (tf) and an increase in temperature of 20°C.

Permanent Constructional Extension = 0.25% of rope length = 500mm

$$\text{Elastic Extension} = \frac{WL}{EA} = \frac{10000 \times 200,000}{6000 \times 615.8} = 540\text{mm}$$

$$\text{Thermal Expansion} = \Delta l = \alpha \cdot l \cdot t = 0.0000125 \times 200,000 \times 20 = 50\text{mm}$$

$$\text{Therefore total extension} = 500 + 540 + 50 = 1090\text{mm}$$

## 8. Pressures between Ropes and Sheaves or Drums

In addition to the bending stresses experienced by wire ropes operating over sheaves or pulleys, ropes are also subjected to radial pressure as they make contact with the sheave. This pressure sets up shearing stresses in the wires, distorts the rope's structure and affects the rate of wear of the sheave grooves. When a rope passes over a sheave, the load on the sheave results from the tension in the rope and the angle of rope contact. It is independent of the diameter of the sheave.

$$\text{Load on bearing} = 2T \sin \frac{\theta}{2}$$

T = rope tension (kg)

$\theta$  = contact angle between rope and sheave or drum

Assuming that the rope is supported in a well fitting groove, then the pressure between the rope and the groove is dependent upon the rope tension and diameter but is independent of the arc of contact.

$$\text{Pressure, } P = \frac{2T}{Dd}$$

P = pressure (kg/cm<sup>2</sup>)

T = rope tension (kg)

D = diameter of sheave or drum (cm)

d = diameter of rope (cm)

Maximum Permissible Pressures

Number of outer wires in strands	Groove material		
	Cast iron kgf/cm <sup>2</sup>	Low carbon cast steel kgf/cm <sup>2</sup>	11 to 13% Mn steel or equivalent alloy steels kgf/cm <sup>2</sup>
5 - 8 Ordinary lay	20	40	105
5 - 8 Lang's lay	25	45	120
9 - 13 Ordinary lay	35	60	175
9 - 13 Lang's lay	40	70	200
14 - 18 Ordinary lay	42	75	210
14 - 18 Lang's lay	47	85	240
Triangular strand	55	100	280

It should be emphasised that this method of estimation of pressure assumes that the area of contact of the rope in the groove is on the full rope diameter, whereas in fact only the crowns of the outer wires are actually in contact with the groove. The local pressures at these contact points may be as high as 5 times those calculated and therefore the values given above cannot be related to the compressive strength of the groove material.

If the pressure is high, the compressive strength of the material

in the groove may be insufficient to prevent excessive wear and indentation and this in turn will damage the outer wires of the rope and effect its working life. As with bending stresses, stresses due to radial pressure increase as the diameter of the sheave decreases. Although high bending stresses generally call for the use of flexible rope constructions having relatively small diameter outer wires, these have less ability to withstand heavy pressures than do the larger wires in the less flexible constructions. If the calculated pressures are too high for the particular material chosen for the sheaves or drums or indentations are being experienced, consideration should be given to an increase in sheave or drum diameter. Such a modification would not only reduce the groove pressure, but would also improve the fatigue life of the rope.

The pressure of the rope against the sheave also causes distortion and flattening of the rope structure. This can be controlled by using sheaves with the correct groove profile which, for general purposes, suggests an optimum groove radius of nominal rope radius +10%. The profile at the bottom of the groove should be circular over an angle of approximately 120°, and the angle of flare between the sides of the sheave should be

Rope grade	Approximate Equivalent	Approximate Hardness	
		Brinell	Rockwell 'C'
Min. Tensile Strength	API 9A Grade		
2160N / mm <sup>2</sup>	EEIPS	480 / 500	52
1960N / mm <sup>2</sup>	EIPS	470 / 480	51
1770N / mm <sup>2</sup>	IPS	445 / 470	49
1570N / mm <sup>2</sup>	PS	405 / 425	45

Suggested pulley hardness: 250-300 Brinell for Mn steel or equivalent alloy steel.

## 9. Bend Fatigue

Bend fatigue testing of ropes usually consists of cycling a length of rope over a sheave while the rope is under a constant tension as part of its ongoing development programme Bridon has tested literally thousands of ropes in this manner over the years on its in-house own design bend testing equipment.

Through this work, Bridon has been able to compare the effects of rope construction, tensile strength, lay direction, sheave size, groove profile and tensile loading on bend fatigue performance under ideal operating conditions. At the same time it has been possible to compare rope life to discard criteria (e.g. as laid down in ISO 4309) with that to complete failure of the rope, i.e. to the point where the rope has been unable to sustain the load any longer. As part of the exercise, it has also been possible to establish the residual breaking strength of the rope at discard level of deterioration.

Effects of D:d Ratio and loading on fatigue life - Typical example Dyform 6

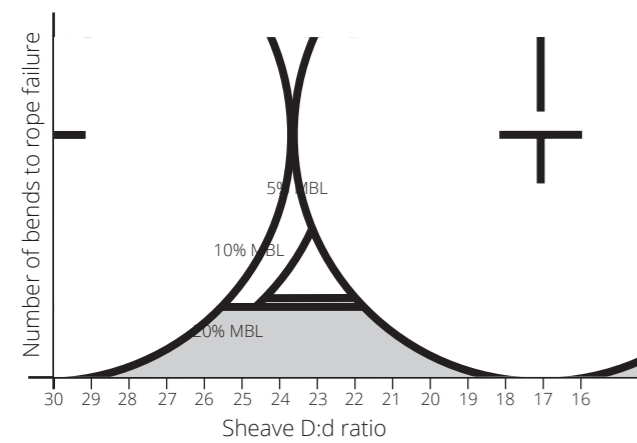

What needs to be recognised, however, is that very few ropes operate under these controlled operating conditions, making it very difficult to use this base information when attempting to predict rope life under other conditions. Other influencing factors, such as dynamic loading, differential loads in the cycle, fleet angle, reeving arrangement, type of coiling on the drum, change in rope direction, sheave alignment, sheave size and groove profile, can have an equally dramatic effect on rope performance.

However, the benefit of such testing can be particularly helpful to the rope manufacturer when developing new or improving existing products.

If designers or operators of equipment are seeking optimum rope

performance or regard bending fatigue life as a key factor in the operation of equipment, such information can be provided by Bridon for guidance purposes.

Service life curve for various D:d ratios

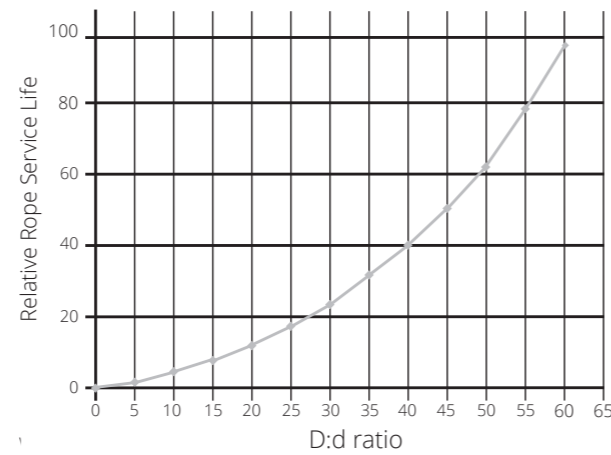

considering the use of a steel wire rope around a minimum D:d ratio, it is generally accepted that below 4:1, the effect on the strength of the rope needs to be considered. Permanent distortions within the rope will occur when using ratios of 10:1 or less, a minimum ratio of 16:1 should be used for a rope operating around sheaves.

Approximate loss in breaking strength due to bending

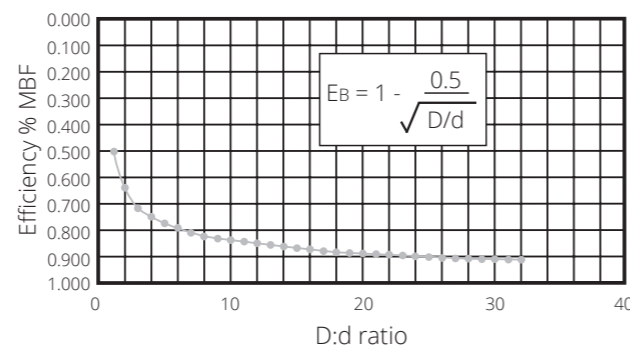

## 10. Fleet Angle

Of all the factors which have an influence on the winding of a rope on a smooth drum, the fleet angle, arguably, has the greatest effect.

Fleet angle is usually defined as the included angle between two lines, one which extends from a fixed sheave to the flange of a drum and the other which extends from the same fixed sheave to the drum in a line perpendicular to the axis of the drum. (See illustration).

Illustration of Fleet Angle

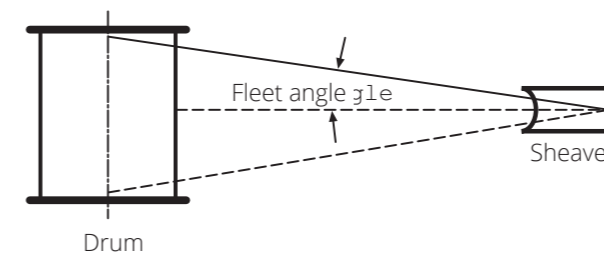

If the drum incorporates helical grooving, the helix angle of the groove needs to be added or subtracted from the fleet angle as described above to determine the actual fleet angle experienced by the rope.

At the drum

When spooling rope onto a drum it is generally recommended that the fleet angle is limited to between 0.5° and 2.5°. If the fleet angle is too small, i.e. less than 0.5°, the rope will tend to pile up at the drum flange and fail to return across the drum. In this situation, the problem may be alleviated by introducing a 'kicker' device or by increasing the fleet angle through the introduction of a sheave or spooling mechanism.

If the rope is allowed to pile up it will eventually roll away from the flange creating a shock load in both the rope and the structure of the mechanism, an undesirable and unsafe operating condition.

Excessively high fleet angles will return the rope across the drum prematurely, creating gaps between wraps of rope close to the flanges as well as increasing the pressure on the rope at the cross-over positions.

Even where helical grooving is provided, large fleet angles will inevitably result in localised areas of mechanical damage as the wires 'pluck' against each other. This is often referred to as 'interference' but the amount can be reduced by selecting a Langs lay rope if the reeving allows. The "interference" effect can also be reduced by employing a Dyform rope which offers a much smoother exterior surface than conventional rope constructions.

Floating sheaves or specially designed fleet angle compensating devices may also be employed to reduce the fleet angle effect.

At the sheave

Where a fleet angle exists as the rope enters a sheave, it initially makes contact with the sheave flange. As the rope continues to pass through the sheave it moves down the flange until it sits in the bottom of the groove. In doing so, even when under tension, the rope will actually roll as well as slide. As a result of the rolling action the rope is twisted, i.e. turn is induced

into or out of the rope, either shortening or lengthening the lay length of the outer layer of strands. As the fleet angle increases so does the amount of twist.

To reduce the amount of twist to an acceptable level the fleet angle should be limited to 2.5° for grooved drums and 1.5° for plain drums and when using rotation-resistant low rotation and parallel-closed ropes the fleet angle should be limited to 1.5°.

However, for some applications it is recognised that for practical reasons it is not always possible to comply with these general recommendations, in which case the rope life could be affected.

### 11. Rope Torque

The problem of torsional instability in hoist ropes would not exist if the ropes could be perfectly torque balanced under load. The torque generated in a wire rope under load is usually directly related to the applied load by a constant 'torque factor'. For a given rope construction the torque factor can be expressed as a proportion of the rope diameter and this is shown below.

Variation with rope construction is relatively small and hence the scope for dramatically changing the stability of a hoisting system is limited. Nevertheless the choice of the correct rope can have a deciding influence, especially in systems which are operating close to the critical limit. It should be noted that the rope torque referred to here is purely that due to tensile loading. No account is taken of the possible residual torque due, for example, to rope manufacture or installation procedures.

Good installation practises are vital to prevent torque build up in your new rope. Winding system designers need to take this into consideration at the development stage. Bridon can advise on all mining installation process's.

Torsional Stability

The torque factors quoted on page 41 are approximate maximum values for the particular constructions. To calculate the torque value for a particular rope size multiply the rope diameter by the nominal rope diameter. Example: for 20mm dia. Tiger 34LR 34x7 Class at 20% of minimum breaking force:-

Torque value = torque factor x rope dia.  
= 0.8% x 20mm  
= 0.16mm

# 11. Rope Torque

To calculate the torque generated in a particular rope when subjected to a tensile load, multiply the load by the torque value and combine the units.

Example: for 20mm dia. Tiger 34LR 34x7 Class at 6000 kg f load

Torque generated = torque value x load  
 = 0.16 . 6000  
 = 960 kgf.mm

## Bending Loads

As the rope is bent over the headsheave or drum, an additional force is induced into the steel which must be added to the static and dynamic tensions to obtain the total force imposed. There are many methods of calculation for this bending force, although the one most commonly used is:

$$\text{Bending force} = \frac{EdA}{D}$$

where E = Elastic Modulus as given under 'Elongation of Wire Rope' - kgf/mm<sup>2</sup>  
 d = diameter of outer wire in rope - mm  
 A = Cross sectional area of rope - mm<sup>2</sup>  
 D = Diameter of sheave or drum - mm

## Size of Outer Wires in Rope

It is sometimes useful to know the size of the outer wires in ropes i.e. when estimating the amount of external wear or calculating bending stress. These can be calculated with reasonable accuracy for all constructions of 6 strand ropes using the following formula.

$$\text{Diameter of outer wires} = \frac{\text{Nominal diameter of rope}}{\sqrt{\text{No. of outer wires per strand} + 3}}$$

Example:  
 26mm diameter 6 x 36 (14/7 and 7/7/1) round strand  
 No. of outer wires per strand = 14  
 Diameter of =  $\frac{26}{\sqrt{14+3}} = 1.5\text{mm}$   
 outer wire 14+3

## Calculations of Drum Capacity

The following formula gives an approximate indication regarding length of rope of a given diameter (d) which can be installed onto a winch/drum.

## Imperial

$$\text{Rope length (ft)} = \frac{(A + B) \times A \times C \times \pi}{12d^2}$$

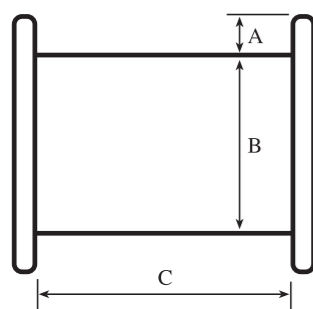

## Metric

$$\text{Rope length (m)} = \frac{(A + B) \times A \times C \times \pi \times 10^6}{d^2}$$

where A, B and C are quoted in metres and d quoted in mm.

NOTE: Ropes are normally manufactured to a maximum oversize tolerance of 4%. Therefore the actual diameter 'd' could be nominal diameter + 4%.

**WARNING**

Wire rope will fail if worn-out, shock loaded, overloaded, misused, damaged, improperly maintained or abused.

- Always inspect wire rope for wear, damage or abuse before use
- Never use wire rope which is worn-out, damaged or abused
- Never overload or shock load a wire rope
- Inform yourself: Read and understand the guidance on product safety given in this catalogue; also read and understand the machinery manufacturer's handbook
- Refer to applicable directives, regulations, standards and codes concerning inspection, examination and rope removal criteria

Protect yourself and others - failure of wire rope may cause serious injury or death!

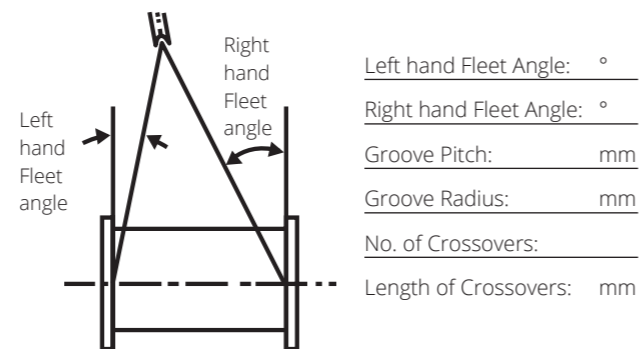

## Rope Oscillation

Drum hoists operating with multiple layers of rope often experience severe oscillation of the rope between the headgear sheave and the hoist drum during some part of the hoisting cycle. Advice should be sought from BRIDON'S Mining Division.

# How to order hoist ropes

Customer information					
<b>I. Particulars of shaft:</b>					
1. Suspended Hoist Rope (From Lowest level to Headgear pulley)					
2. Type of ventilation (upcast/downcast)					
3. Shaft water inflow					
4. pH value					
5. Chloride content					
6. Range of temperature variation					
7. Other conditions affecting the rope					
<b>II. Particulars of hoisting:</b>					
1. Type of hoisting		One Rope	Multirope	Multi Layer Coiling	No. of Layers
		Cage	Skip	Kibble	Counterweight
2. Application		Mineral			
		Mineral & Manriding			
3. Speed of lifting, m/sec					
4. Acceleration of lifting, m/sec <sup>2</sup>					
5. Preventative deceleration, m/sec <sup>2</sup>					
6. Guides		If Available			
		Rope			
		Rigid:	Wood	Steel	Rollers
					Shoe
<b>III. Particulars of the winder:</b>					
1. Type		Drum Winder	Friction Winder-tower or Ground Mounted Drum		
2. Drum diameter					
3. Drum width					
4. Diameter of Headgear pulley, (mm)					
5. Width of Headgear Pulley					
6. Diameter tolerance taking into account the bottom of the pulley					
7. Type of lining					
8. Diameter of deflector sheave (Tower mounted Friction winding only)					
9. Number of hoist ropes					
10. Number of balance ropes					
11. Type of balance ropes					
12. Weight of 1 m of balance ropes					
13. Loop radius of balance ropes					
<b>IV. Particulars of the hoist conveyance:</b>					
1. Mass of empty conveyance with suspension gear of hoist and balance ropes, tonnes					
2. Mass of conveyance (2) or counterweight with suspension gear, tonnes					
3. Mass of payload, tonnes					
4. Number of cycles per day/month					
<b>V. Particulars of the rope:</b>					
1. Rope Specification					
2. Nominal diameter, mm					
3. Construction					
4. Direction and type of lay					
5. Type of core					
6. Weight of 1 m, kg					
7. Length of the rope, m					
8. Number of individual lengths					
9. Preferred Lubrication					
10. Galvanised/Ungalvanised					
11. Rope Tensile, kN/mm <sup>2</sup>					
12. Minimum Breaking Load, kgf					
13. Nominal Breaking Load, kgf					
14. Aggr. Breaking Load of all wires, kgf					
15. Lubrication		Core:	Strands:	Rope:	
16. Minimum Safety Factor Required		Aggregate Breaking Load		Please tick one	
		Minimum Breaking Load			
17. Please state any local regulations that need to be adhered to					
18. Causes of rope failure during operation					
19. Notes:					

## Summary Technical Information (For guidance purposes only)

Bridon supply a range of 'Tiger' High Performance steel wire ropes specifically designed and manufactured to meet the needs of today's mine winder specifications and the demanding applications to which they are exposed. High performance ropes are normally selected by customers when they require the specific characteristics of improved performance, high strength, low extension or low rotation.

Rope Construction	Rope Modulus at 20% of MBF kN/mm <sup>2</sup>	Torque Factor at 20% of MBF	
		%	
		Ordinary	Langs
TIGER 6R F 6 x 7 Class	61.80	8.1	12.0
TIGER 6R F 6 x 19 Class	54.00	8.1	12.0
TIGER 6R F 6 x 36 Class	50.80	8.1	12.0
TIGER Dyform 6R F 6 x 7 Class	66.90	8.1	12.0
TIGER Dyform 6R F 6 x 19 Class	54.20	8.1	12.0
TIGER Dyform 6R F 6 x 36 Class	50.30	8.1	12.0
TIGER 6T F 6 x 8 Class Single layer	68.70	n/a	13.4
TIGER 6T F 6 x 25 Class Compound layer	61.80	n/a	13.4
TIGER 18M F 18 x 7 Class	42.30	n/a	6.6
TIGER 18M F 18 x 19 Class	41.80	n/a	6.6
TIGER Dyform 18 18 x 7 Class	65.70	n/a	4.5
TIGER Dyform 18 18 x 19 Class	65.70	n/a	4.5
TIGER 34M F 34 x 7 Class	41.20	n/a	5.1
TIGER 34M F 34 x 19 Class	40.70	n/a	5.1
TIGER 34LR 34 x 7 Class	72.60	n/a	2.3
TIGER 34LR 34 x 19 Class	72.60	n/a	2.3
TIGER Superflex 14 x 6	40.20	n/a	3.9
TIGER Superflex 17 x 6	38.30	n/a	2.6
TIGER Superflex 20 x 6	36.30	n/a	1.3
TIGER 6R CDR 6 x 19 Class	50.00	n/a	12.0
TIGER 6R CDR 6 x 25 Class	46.40	n/a	12.0
TIGER 6R CDR 6 x 31 Class	46.40	n/a	12.0
TIGER Dyform 6R CDR 6 x 19 Class	54.20	n/a	12.0
TIGER Dyform 6R CDR 6 x 26 Class	50.30	n/a	12.0
TIGER Dyform 6R CDR 6 x 31 Class	50.30	n/a	12.0
TIGER Zebra CDR 6 x 19	63.90	n/a	9.6
TIGER Zebra CDR 6 x 26	59.30	n/a	9.6
TIGER Zebra CDR 6 x 31	59.30	n/a	9.6
TIGER FL Hoist Class	98.10		Variable
TIGER FL Aerial Track Class	110.00		Variable
TIGER HL Guide Class	117.00		Variable
TIGER 24LS	67.2	n/a	5.8
TIGER Dyform 24LS	77.6	n/a	5.8
TIGER 34M SPI	40.7	n/a	5.1

## Guide to Examination

The continued safe operation of lifting equipment, lifting accessories (e.g. slings) and other systems employing wire rope, depends on the operation of well programmed periodic rope examinations and the assessment by the competent person of the fitness of the rope for further service.

Examination and discard of ropes by the competent person should be in accordance with the instructions given in the original equipment manufacturer's handbook. In addition, account should be taken of any local or application specific Regulations.

The competent person should also be familiar, as appropriate, with the latest versions of related International, European or National standards such as ISO 4309

"Cranes - Wire ropes - code of practice for examination".

Particular attention must be paid to those sections of rope which experience has shown to be liable to deterioration. Excessive wear, broken wires, distortions and corrosion are the more common visible signs of deterioration.

Note: This publication has been prepared as an aid for rope examination and should not be regarded as a substitute for the competent person.

Wear is a normal feature of rope service and the use of the correct rope construction ensures that it remains a secondary aspect of deterioration. Lubrication may help to reduce wear.

Broken wires are a normal feature of rope service towards the end of the rope's life, resulting from bending fatigue and wear. The local break up of wires may indicate some mechanical fault in the equipment. Correct lubrication in service will increase fatigue performance.

Distortions are usually as a result of mechanical damage, and if severe, can considerably affect rope strength.

Visible rusting indicates a lack of suitable lubrication, resulting in corrosion. Pitting of external wire surfaces becomes evident in some circumstances. Broken wires ultimately result.

Internal corrosion occurs in some environments when lubrication is inadequate or of an unsuitable type. Reduction in rope diameter will frequently guide the observer to this condition. Confirmation can only be made by opening the rope with clamps or the correct use of spike and needle to facilitate internal inspection.

Note: Non-destructive testing (NDT) using electromagnetic means may also be used to detect broken wires and/or loss in metallic area. This method complements the visual examination but does not replace it.

Pictures courtesy of S.M.R.E. Crown Copyright 1966

Some of the More Common Types of Wire Fractures Can Include:

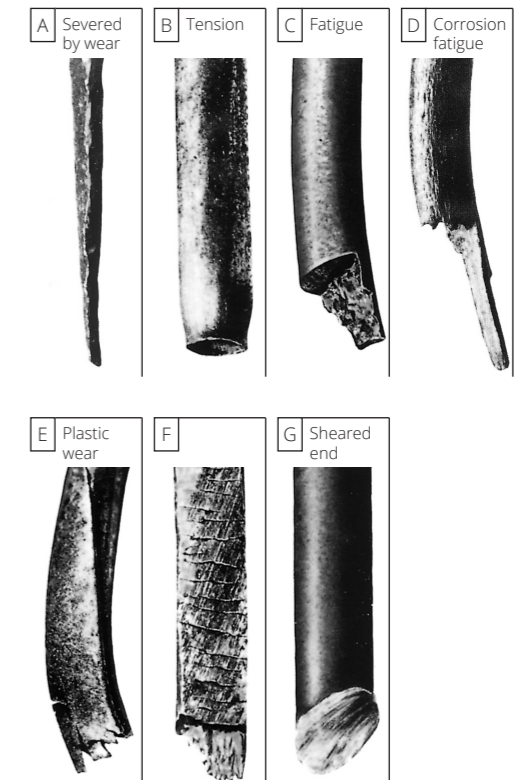

### Factors Affecting Rope Performance

Multi-layer coiling of the rope on the drum can result in severe distortion in the underlying layers.

Bad coiling (due to excessive fleet angles or slack winding) can result in mechanical damage, shown as severe crushing, and may cause shock loading during operation.

Small diameter sheaves can result in permanent set of the rope, and will certainly lead to early wire breaks due to fatigue.

Oversize grooves offer insufficient support to the rope leading to increased localised pressure, flattening of the rope and premature wire fractures. Grooves are deemed to be oversize when the groove diameter exceeds the nominal rope diameter by more than 15% steel, 20% polyurethane liners.

Undersize grooves in sheaves will crush and deform the rope, often leading to two clear patterns of wear and associated wire breaks.











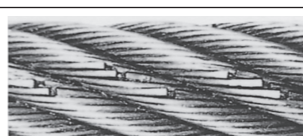

Excessive angle of fleet can result in severe wear of the rope due to scrubbing against adjacent laps on the drum. Rope deterioration at the termination may occur in the form of broken wires. An excessive angle of fleet can also induce rotation causing torsional imbalance.

# troubleshooting guide.

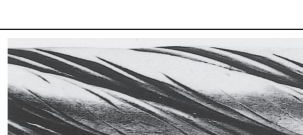
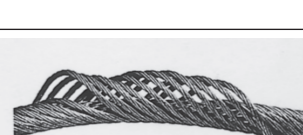

## Troubleshooting Guide

Typical examples of Wire Rope deterioration

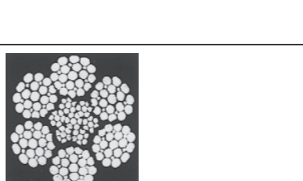
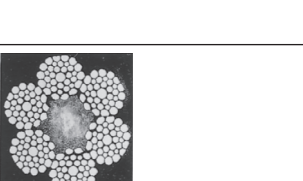
- |   |   |  |   |
|---|---|--|---|
| <p>1 Mechanical damage due to rope movement over sharp edged projection whilst under load.</p>  |    | <p>9 Typical wire fractures as a result of bend fatigue.</p>                                   |    |
| <p>2 Localised wear due to abrasion on supporting structure.</p>  |    | <p>10 Wire fractures at the strand, or core interface, as distinct from 'crown' fractures.</p> |    |
| <p>3 Narrow path of wear resulting in fatigue fractures, caused by working in a grossly oversize groove, or over small support rollers.</p> |    | <p>11 Break up of IWRC resulting from high stress application.</p>                             |    |
| <p>4 Two parallel paths of broken wires are indicative of bending through an undersize groove in the sheave.</p>                            |   | <p>12 Looped wires as a result of torsional imbalance and/or shock loading.</p>                |   |
| <p>5 Severe wear, associated with high tread pressure.</p>  |  | <p>13 Typical example of localised wear and deformation.</p>                                   |  |
| <p>6 Severe wear in Langs Lay, caused by abrasion.</p>  |  | <p>14 Multi-strand rope 'bird caged' due to torsional imbalance.</p>                           |  |
| <p>7 Severe corrosion.</p>  |  | <p>15 Protrusion of rope centre resulting from build up of turn.</p>                           |  |
| <p>8 Internal corrosion whilst external surface shows little evidence of deterioration.</p>   |  | <p>16 Substantial wear and severe internal corrosion.</p>                                      |  |

## Troubleshooting Guide

The following is a simplified guide to common wire rope problems. More detailed advice can be obtained from any Bridon distributor. In the event of no other standard being applicable, Bridon recommends that ropes are inspected/examined in accordance with ISO 4309.

Problem	Cause/Action
Mechanical damage caused by the rope contacting the structure of the installation on which it is operating or an external structure - usually of a localised nature.	<ul style="list-style-type: none"> <li>• Generally results from operational conditions.</li> <li>• Check sheave guards and support/guide sheaves to ensure that the rope has not "jumped out" of the intended reeving system.</li> <li>• Review operating conditions.</li> </ul>
Opening of strands in rotation resistant, low rotation and parallel closed ropes - in extreme circumstances the rope may develop a "birdcage distortion" or protrusion of inner strands.  Note - rotation resistant and low rotation ropes are designed with a specific strand gap which may be apparent on delivery in an off tension condition. These gaps will close under load and will have no effect on the operational performance of the rope.	<ul style="list-style-type: none"> <li>• Check sheave and drum groove radii using sheave gauge to ensure that they are no smaller than nominal rope radius +5% - Bridon recommends that the sheave and drum groove radii are checked prior to any rope installation.</li> <li>• Repair or replace drum/sheaves if necessary.</li> <li>• Check fleet angles in the reeving system - a fleet angle in excess of 1.5 degrees may cause distortion.</li> <li>• Check installation method - turn induced during installation can cause excessive rope rotation resulting in distortion.</li> <li>• Check if the rope has been cut "on site" prior to installation or cut to remove a damaged portion from the end of the rope. If so, was the correct cutting procedure used? Incorrect cutting of rotation resistant, low rotation and parallel closed ropes can cause distortion in operation.</li> <li>• Rope may have experienced a shock load.</li> </ul>
Broken wires or crushed or flattened rope on lower layers at crossover points in multi-layer coiling situations.  Wire breaks usually resulting from crushing or abrasion.	<ul style="list-style-type: none"> <li>• Check tension on underlying layers. Bridon recommends an installation tension of between 2% and 10% of the minimum breaking force of the wire rope. Care should be taken to ensure that tension is retained in service. Insufficient tension will result in these lower layers being more prone to crushing damage.</li> <li>• Review wire rope construction. Dyform wire ropes are more resistant to crushing on underlying layers than conventional rope constructions.</li> <li>• Do not use more rope than necessary.</li> <li>• Check drum diameter. Insufficient bending ratio increases tread pressure.</li> </ul>

## Troubleshooting Guide

Problem	Cause/Action
Wires looping from strands.	<ul style="list-style-type: none"> <li>• Insufficient service dressing.</li> <li>• Consider alternative rope construction.</li> <li>• If wires are looping out of the rope underneath a crossover point, there may be insufficient tension on the lower wraps on the drum.</li> <li>• Check for areas of rope crushing or distortion.</li> </ul>
"Pigtail" or severe spiralling in rope.	<ul style="list-style-type: none"> <li>• Check that the sheave and drum diameter is large enough - Bridon recommends a minimum ratio of rope/sheave to nominal drum diameter depending on the chosen construction, please contact Bridon for further reference.</li> <li>• Indicates that the rope has run over a small radius or sharp edge.</li> <li>• Check to see if the rope has "jumped off" a sheave and has run over a shaft.</li> </ul>
Two single axial lines of broken wires running along the length of the rope approximately 120 degrees apart indicating that the rope is being "nipped" in a tight sheave.	<ul style="list-style-type: none"> <li>• Check sheave and drum groove radii using sheave gauge to ensure that they are no smaller than nominal rope radius + 5% - Bridon would recommend that the sheave/drum groove radii are checked prior to any rope installation.</li> <li>• Repair or replace drum/sheaves if necessary.</li> </ul>
One line of broken wires running along the length of the rope indicating insufficient support for the rope, generally caused by oversized sheave or drum grooving.	<ul style="list-style-type: none"> <li>• Check to see if the groove diameter is no greater than 15% greater than the nominal rope diameter.</li> <li>• Repair or replace drum/sheaves if necessary.</li> <li>• Check for contact damage.</li> </ul>
Short rope life resulting from evenly/randomly distributed bend fatigue wire breaks caused by bending through the reeving system.  Fatigue induced wire breaks are characterised by flat ends on the broken wires.	<ul style="list-style-type: none"> <li>• Bending fatigue is accelerated as the load increases and as the bending radius decreases. Consider whether either factor can be improved.</li> <li>• Check wire rope construction - Dyform ropes are capable of doubling the bending fatigue life of a conventional steel wire rope.</li> </ul>



## Troubleshooting Guide

Problem	Cause/Action
<p>Short rope life resulting from localised bend fatigue wire breaks.</p> <p>Fatigue induced wire breaks are characterised by flat ends on the broken wires.</p>	<ul style="list-style-type: none"> <li>Bending fatigue is accelerated as the load increases and as the bending radius decreases. Consider whether either factor can be improved.</li> <li>Check wire rope construction - Dyform ropes are capable of doubling the bending fatigue life of a conventional steel wire rope.</li> <li>Localised fatigue breaks indicate continuous repetitive bends over a short length. Consider whether it is economic to periodically shorten the rope in order to move the rope through the system and progressively expose fresh rope to the severe bending zone. In order to facilitate this procedure it may be necessary to begin operating with a slightly longer length of rope.</li> </ul>
<p>Broken rope - ropes are likely to break when subjected to substantial overload or misuse particularly when a rope has already been subjected to mechanical damage.</p> <p>Corrosion of the rope both internally and/or externally can also result in a significant loss in metallic area. The rope strength is reduced to a level where it is unable to sustain the normal working load.</p>	<ul style="list-style-type: none"> <li>Review operating conditions.</li> </ul>
<p>Wave or corkscrew deformations normally associated with multi-strand ropes.</p>	<ul style="list-style-type: none"> <li>Check sheave and drum groove radii using sheave gauge to ensure that they are no smaller than nominal rope radius +5% - Bridon recommends that the sheave/drum groove radii are checked prior to any rope installation.</li> <li>Repair or replace drum/sheaves if necessary.</li> <li>Check fleet angles in the reeving system - a fleet angle in excess of 1.5 degrees may cause distortion .</li> <li>Check that rope end has been secured in accordance with manufacturers instructions.</li> <li>Check operating conditions for induced turn.</li> <li>Good installation practices are vital to prevent torque build up in your new rope. Installation at 90 degrees to the main drum will add torque to all stranded/multi-strand ropes.</li> </ul>
<p>Rotation of the load in a single fall system.</p>	<ul style="list-style-type: none"> <li>Review rope selection.</li> <li>Consider use of rotation resistant or low rotation rope.</li> </ul>
<p>Rotation of the load in a multi - fall system resulting in "cabling" of the rope falls.</p> <p>Possibly due to induced turn during installation or operation.</p>	<ul style="list-style-type: none"> <li>Review rope selection.</li> <li>Consider use of rotation resistant or low rotation rope.</li> <li>Review installation procedure or operating procedures.</li> </ul>
<p>Core protrusion or broken core in single layer six or eight strand rope.</p>	<ul style="list-style-type: none"> <li>Caused by repetitive shock loading - review operating conditions.</li> </ul>

## Troubleshooting Guide

Problem	Cause/Action
<p>Rope accumulating or "stacking" at drum flange - due to insufficient fleet angle.</p>	<ul style="list-style-type: none"> <li>Review drum design with original equipment manufacturer - consider adding rope kicker, fleeting sheave etc.</li> </ul>
<p>Sunken wraps of rope on the drum normally associated with insufficient support from lower layers of rope or grooving.</p>	<ul style="list-style-type: none"> <li>Check correct rope diameter.</li> <li>If grooved drum check groove pitch.</li> <li>Check tension on underlying layers - Bridon recommend an installation tension of between 2% and 10% of the minimum breaking force of the wire rope - Care should be taken to ensure that tension is retained in service. Insufficient tension will result in these lower layers being more prone to crushing damage.</li> <li>Make sure that the correct rope length is being used. Too much rope (which may not be necessary) may aggravate the problem.</li> </ul>
<p>Short rope life induced by excessive wear and abrasion.</p>	<ul style="list-style-type: none"> <li>Check fleet angle to drum.</li> <li>Check general alignment of sheaves in the reeving system.</li> <li>Check that all sheaves are free to rotate.</li> <li>Review rope selection. The smooth surface of Dyform wire ropes gives better contact with drum and sheaves and offers improved resistance to "interference" between adjacent laps of rope.</li> </ul>
<p>External corrosion.</p>	<ul style="list-style-type: none"> <li>Consider selection of galvanised rope.</li> <li>Review level and type of service dressing.</li> </ul>
<p>Internal corrosion.</p>	<ul style="list-style-type: none"> <li>Consider selection of galvanised rope.</li> <li>Review frequency amount and type of service dressing.</li> <li>Consider selection of plastic impregnated (PI) wire rope.</li> </ul>

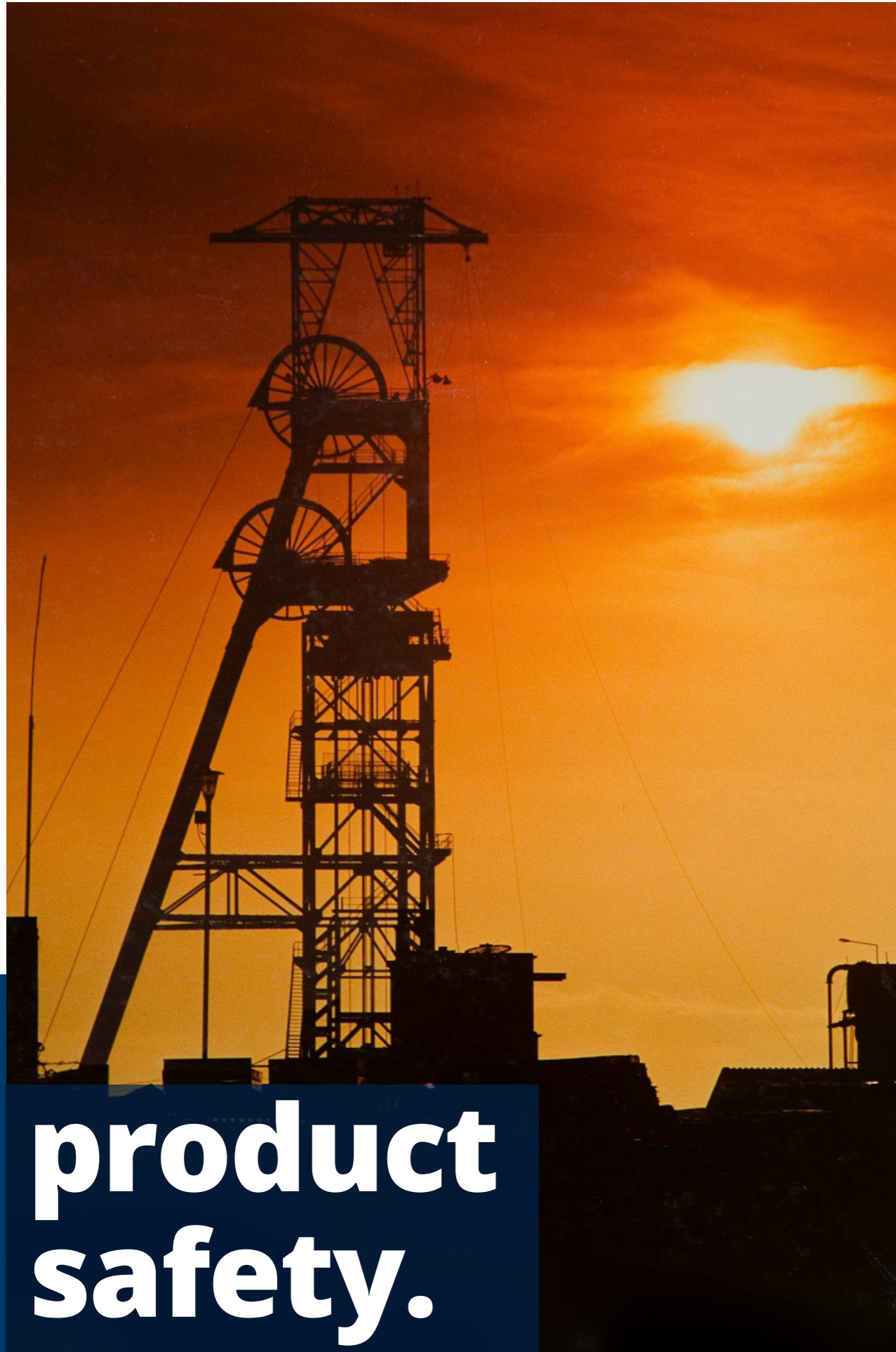

**product  
safety.**

## Product Safety: Instructions & Warnings on the use of steel wire rope

The following Instructions and Warnings combine to provide guidance on Product Safety and are intended for use by those already having a working knowledge of wire ropes, as well as the new user. They should be read, followed and passed on to others.

Failure to read, understand and follow these instructions could result in harmful and damaging consequences.

A 'Warning' statement indicates a potential hazardous situation which could result in a significant reduction in rope performance and/or put at risk, either directly or indirectly, the safety or health of those persons within the danger zone of the rope and its associated equipment.

Note: As a result of the creation of the single European market and the 'New Approach' Directives which set out 'essential requirements' (e.g. for safety); designers, manufacturers, suppliers, specifiers and users need to keep themselves abreast of any changes to the appropriate Regulations and national standards.

### 1. Storage

- 1.1 Unwrap the rope and examine the rope immediately after delivery to check its identification and condition and verify that it is in accordance with the details on the Certificates and/or other relevant documents.

Note: The rope should not be used for lifting purposes without the user having a valid Certificate in his possession.

Check the rope diameter and examine any rope terminations to ensure that they are compatible with the equipment or machinery to which they are to be fitted. (See Fig. 1)

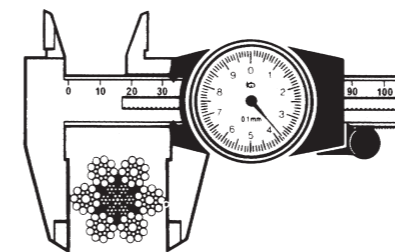

Fig 1

waterproof material if the delivery site conditions preclude inside storage.

Rotate the reel periodically during long periods of storage, particularly in warm environments, to prevent migration of the lubricant from the rope.

#### WARNING

Never store wire rope in areas subject to elevated temperatures as this may seriously affect its future performance. In extreme cases its original as-manufactured strength may be severely reduced rendering it unfit for safe use.

Ensure that the rope does not make any direct contact with the floor and that there is a flow of air under the reel.

#### WARNING

Failure to do so may result in the rope becoming contaminated with foreign matter and start the onset of corrosion before the rope is even put to work.

Support the reel on a simple A-frame or cradle, located on ground which is capable of supporting the total mass of rope and reel. (See Fig. 2) Ensure that the rope is stored where it is not likely to be affected by chemical fumes, steam or other corrosive agents.

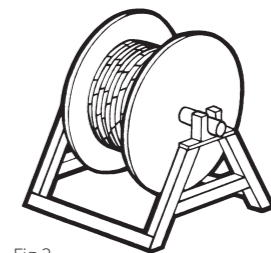

Fig 2

#### WARNING

Failure to do so may seriously affect its condition rendering it unfit for safe use.

- 1.3 Examine ropes in storage periodically and, when necessary, apply a suitable dressing which is compatible with the manufacturing lubricant. Contact the rope supplier, Bridon or original equipment manufacturer's (OEM) manual for guidance on types of dressings available, methods of application and equipment for the various types of ropes and applications.

Re-wrap the rope unless it is obvious that this will be detrimental to rope preservation. (Refer to the relevant Product Data sheets on rope dressings for more detailed information.)

#### WARNING

Failure to apply the correct dressing may render the original manufacturing lubricant ineffective and rope performance may be significantly affected.

Ensure that the rope is stored and protected in such a manner that it will not be exposed to any accidental damage either during the storage period or when placing the rope in, or taking it out of storage.

## Product Safety: Instructions & Warnings on the use of steel wire rope

### WARNING

Failure to carry out or pay attention to any of the above could result in a loss of strength and/or a reduction in performance. In extreme cases the rope may be unfit for safe use.

#### 2. Certification and Marking

Make sure that the relevant Certificate has been obtained before taking the rope into use for a lifting operation. (Refer to statutory requirements)

Check to verify that the marking on the rope or its package matches the relevant Certificate.

Note: The rating of a component part of a machine or lifting accessory is the responsibility of the designer of the machine or accessory. Any re-rating of a lifting accessory must be approved by a competent person.

Retain the Certificate in a safe place for identification of the rope when carrying out subsequent periodic statutory examinations in service. (Refer to statutory requirements)

#### 3. Handling and Installation

3.1 Handling and installation of the rope should be carried out in accordance with a detailed plan and should be supervised by a competent person.

### WARNING

Incorrectly supervised handling and installation procedures may result in serious injury to persons in the vicinity of the operation as well as those persons directly involved in the handling and installation.

3.2 Wear suitable protective clothing such as overalls, industrial gloves, helmet, eye protectors and safety footwear (and respirator, particularly where the emission of fumes due to heat is likely).

### WARNING

Failure to wear suitable protective clothing and equipment may result in skin problems from over exposure to certain types of rope lubricants and dressings; burns from sparks, rope ends, molten lubricants and metals when cutting ropes or preparing sockets for re-use; respiratory or other internal problems from the inhalation of fumes when cutting ropes or preparing sockets for re-use; eye injuries from sparks when cutting ropes; lacerations to the body from wire and rope ends; bruising of the body and damage to limbs due to rope recoil, backlash and any sudden deviation from the line of path of rope.

3.3 Ensure that the correct rope has been supplied by checking to see that the description on the Certificate is in accordance with that specified in the purchaser's order.

3.4 Check by measurement that the nominal diameter of the new rope conforms to the nominal size stated on the Certificate.

For verification purposes, measure the diameter by using a suitable rope vernier fitted with jaws broad enough to cover not less than two adjacent strands. Take two sets of measurements spaced at least 1 metre apart, ensuring that they are taken at the largest cross-sectional dimension of the rope. At each point take measurements at right angles to each other.

The average of these four measurements should be within the tolerances specified in the appropriate Standard or Specification.

For a more general assessment of rope diameter use a rope calliper. (See Fig 1)

3.5 Examine the rope visually to ensure that no damage or obvious signs of deterioration have taken place during storage or transportation to the installation site.

3.6 Check the working area around the equipment for any potential hazards which may affect the safe installation of the rope.

3.7 Check the condition of the rope-related equipment in accordance with the OEM's instructions. Include the following -

#### Sheave and Drum Sizes

Regulations throughout the world quote various minimum D:d ratios for differing rope constructions and these must be considered when selecting a suitable hoist rope. However as guidance the following D:d ratios are recommended.

6 Stranded ropes 80:1

Multi Stranded ropes 80:1

Locked coil ropes 100-120:1 depending upon rope diameter.

(In addition the drum to outer wire ratio should be between 1000 and 1500:1)

Factors such as speed can necessitate an increase in the D:d ratio and in certain circumstances a D:d ratio below the recommended value can be tolerated but some reduction in rope life should be expected.

BRIDON's Mining Division will be pleased to advise on this subject.

#### Sheave Grooves

Groove diameters should be such that they can accommodate a new rope taking into account the relevant oversize tolerance and the fleet angles involved to provide adequate circumferential support.

## Product Safety: Instructions & Warnings on the use of steel wire rope

A groove diameter of 7.5% greater than the nominal rope diameter is normally acceptable. However in certain cases experience has shown that clearances between 10 and 12.5% are required to obtain optimum performance.

Before installing a new rope all sheave grooves should be checked to ensure they provide the recommended clearance.

#### Drum Grooves

On single layer drum hoists spiral grooving is recommended. Where multi-layer coiling is necessary then parallel grooves or one of the patterned coiling systems should be used. In all cases correct pitch, clearance and groove depth are essential to obtain good rope performance.

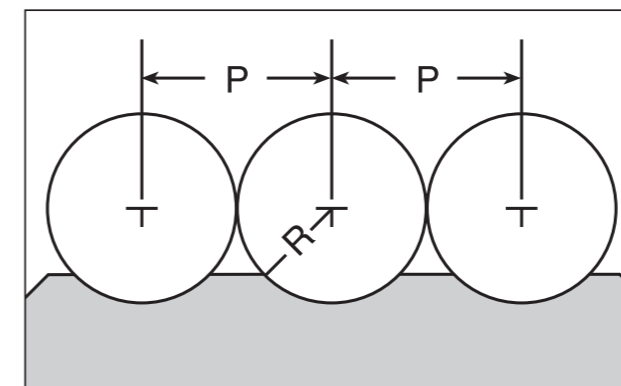

Dimensions for grooving of drums

General recommendations for stranded ropes

$P = \text{nominal diameter} + 5\%$

$R = \text{nominal radius} + 7.5\%$

A gap between the last turn on the bottom layer of rope on the drum and the flange can be corrected by fitting a packing (or false cheek) of suitable thickness on the inside of the flange.

### WARNING

Failure to carry out any of the above could result in unsatisfactory and unsafe rope performance.

Note: Grooves must have clearance for the rope and provide adequate circumferential support to allow for free movement of the strands and facilitate bending. When grooves become worn and the rope is pinched at the sides, strand and wire movement is restricted and the ability of the rope to bend is reduced. (See Fig. 4)

Fig 4

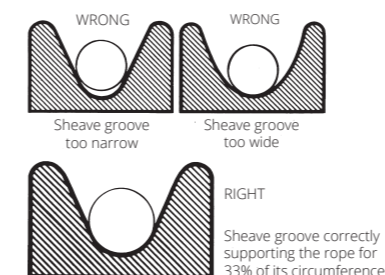

When a new rope is fitted a variation in size compared with the old worn rope will be apparent. The new rope may not fit correctly into the previously worn groove profile and unnecessary wear and rope distortion is likely to occur. This may be remedied by machining out the grooves before the new rope is installed. Before carrying out such action the sheaves or drum should be examined to ensure that there will be sufficient strength remaining in the underlying material to safely support the rope.

The competent person should be familiar with the requirements of the appropriate application/machinery standard.

Note: General guidance to users is given in ISO 4309 Code of practice for the selection, care and maintenance of steel wire rope.

Transfer the wire rope carefully from the storage area to the installation site.

#### Coils

Place the coil on the ground and roll it out straight ensuring that it does not become contaminated with dust/grit, moisture or any other harmful material. (See Fig. 5)

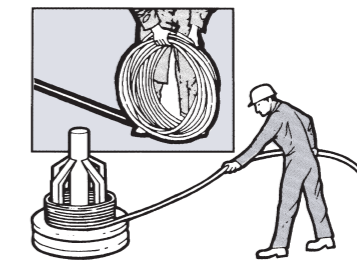

Fig 5

If the coil is too large to physically handle it may be placed on a 'swift' turntable and the outside end of the rope pulled out allowing the coil to rotate. (See Fig. 5)

### WARNING

Never pull a rope away from a stationary coil as this will induce turn into the rope and kinks will form. These will adversely affect rope performance. (See Fig. 6)



Fig 6  
WRONG  
Note the kinks forming

## Product Safety: Instructions & Warnings on the use of steel wire rope

### Reels

Pass a shaft through the reel and place the reel in a suitable stand which allows it to rotate and be braked to avoid overrun during installation. Where multi-layer coiling is involved it may be necessary for the reel to be placed in equipment which has the capability of providing a back tension in the rope as it is being transferred from reel to drum. This is to ensure that the underlying (and subsequent) laps are wound tightly on the drum. (See Fig. 7)

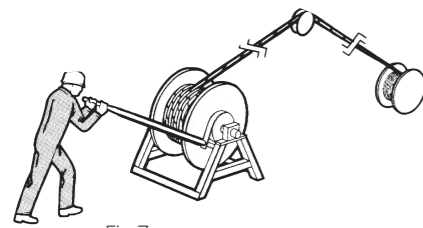

Fig 7

Position the reel and stand such that the fleet angle during installation is limited to 1.5 degrees. (See Fig. 8)

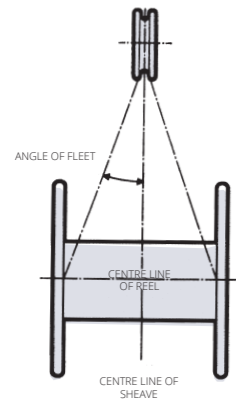

Fig 8

If a loop forms in the rope ensure that it does not tighten to form a kink.

#### WARNING

A kink can severely affect the strength of a six strand rope and can result in distortion of a rotation-resistant or low rotation rope leading to its immediate discard.

Ensure that the reel stand is mounted so as not to create a reverse bend during reeving (i.e. for a winch drum with an overlap rope, take the rope off the top of the reel). (See Fig. 7)

- 3.9 Ensure that any equipment or machinery to be roped is correctly and safely positioned and isolated from normal usage before installation commences. Refer to the OEM's instruction manual and the relevant 'Code of Practice'.
- 3.10 When releasing the outboard end of the rope from a reel or coil, ensure that this is done in a controlled manner. On release of the bindings and servings used for packaging, the rope will want to straighten itself from its previously bent position. Unless controlled, this could be a violent action. Stand clear.

#### WARNING

Failure to control could result in injury.

## Product Safety: Instructions & Warnings on the use of steel wire rope

- 3.11 Monitor the rope carefully as it is being pulled into the system and make sure that it is not obstructed by any part of the structure or mechanism which may cause the rope to come free.

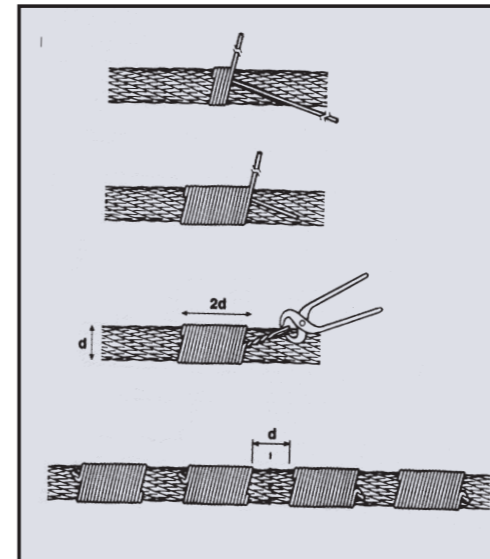

Fig 10

#### WARNING

Failure to monitor during this operation could result in injury.

This entire operation should be carried out carefully and slowly under the supervision of a competent person.

- 3.12 Take particular care and note the manufacturer's instructions when the rope is required to be cut. Apply secure servings on both sides of the cut mark. (See Fig. 10 for typical method of applying a serving to a multi-layer rope.)

Ensure that the length of serving is at least equal to two rope diameters. (Note: Special servings are required for spiral ropes, i.e. spiral strand and locked coil.)

Length of serving for locked coil winding ropes and half locked coil guide ropes

The length of rope to be served depends on the object of the serving and on the size and type of the rope. If the serving is to restrain the cut end of a rope it must be longer than one intended to restrain the end of a short sample to be cut from a rope. A rope of the stranded type exerts only a moderate bursting force on a serving but a large locked coil rope exerts a considerable bursting force and, should the serving burst, the rope will unlay itself violently over a long length. Thus, for the cut end of a stranded rope, two servings each of a length at least six times the rope diameter should be used and kept in place until the rope end is otherwise secured. For the cut end of a large locked coil rope a serving or servings of each length of twenty times the rope diameter is advisable, (FLCWR's to be served with tinned annealed single wire serving, then secured by soldering these wires together, refer to Bridon for further technical information). The 'buried wire' with multi-strand serving wire should not be used with rotation resistant ropes. These servings should be backed up by a minimum of six two-bolt clamps set clear of the served length until the rope end is otherwise secured. Servings should be left permanently on locked coil winding ropes so that there is one about 0.6m (2ft) clear of the capel to allow proper examination of the rope at this point and another between the capel and the nearest pulley or driving sheave in the head frame. This is to localise any unlaying of the rope end, or of broken wires, in the event of an incident.

One serving either side of the cut is normally sufficient for preformed ropes. For non-preformed ropes, multi-layer (i.e. rotation-resistant and low rotation ropes) and parallel closed ropes (i.e. DSC ropes) a minimum of two servings each side of the cut will be necessary (See Fig. 10).

Arrange and position the rope in such a manner that at the completion of the cutting operation the rope ends will remain in position, thus avoiding any backlash or any other undesirable movement.

Cut the rope with a high speed abrasive disc cutter. Other suitable mechanical or hydraulic shearing equipment may be used although not recommended when a rope end is required to be welded or brazed.

For serving instructions for FL and HL ropes refer to Bridon.

## Product Safety: Instructions & Warnings on the use of steel wire rope

### ⚠️ WARNING

When using a disc cutter be aware of the danger from sparks, disc fragmentation and fumes. (Refer 3.2.)

Ensure adequate ventilation to avoid any build-up of fumes from the rope and its constituent parts including any fibre core (natural or synthetic) any rope lubricant(s) and any synthetic filling and/or covering material.

### ⚠️ WARNING

Some special ropes contain synthetic material which, when heated to a temperature higher than normal production processing temperatures, will decompose and may give off toxic fumes.

### ⚠️ WARNING

Rope produced from carbon steel wires in the form shipped is not considered a health hazard. During subsequent processing (e.g. cutting, welding, grinding, cleaning) dust and fumes may be produced which contain elements which may affect exposed workers.

The products used in the manufacture of steel wire ropes for lubrication and protection present minimal hazard to the user in the form shipped. The user must however, take reasonable care to minimise skin and eye contact and also avoid breathing their vapour and mist.

After cutting, the rope cross-sections of non-preformed ropes, multi-layer ropes and parallel closed ropes must be welded, brazed or fused and tapered such that all wires and strands in the rope are completely secured.

### ⚠️ WARNING

Failure to correctly secure the rope end is likely to lead to slackness, distortions, premature removal from service and a reduction in the breaking force of the rope.

- 3.13 Ensure that any fittings such as clamps or fixtures are clean and undamaged before securing rope ends.

Make sure that all fittings are secure in accordance with the OEM's instruction manual or manufacturer's instructions and take particular note of any specific safety requirements e.g. torque values (and frequency of any re-application of torque).

When terminating a rope end with a wedge socket, ensure that the rope tail cannot withdraw through the socket by securing a clamp to the tail or by following the manufacturer's instructions.

(See Fig. 11 for two recommended methods of securing the rope tail of a wedge socket termination).

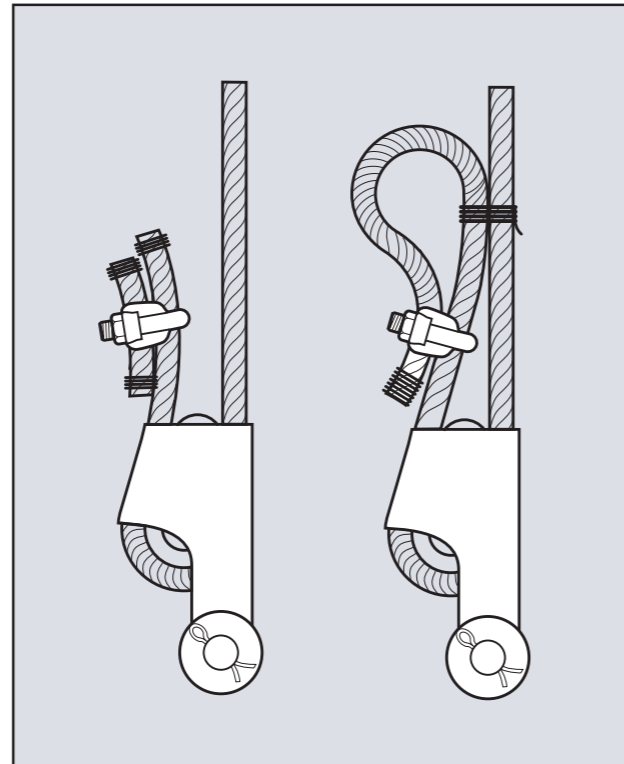

Fig 11

The loop back method uses a rope grip and the loop should be lashed to the live part of rope by a soft wire serving or tape to prevent flexing of the rope in service.

The method of looping back should not be used if there is a possibility of interference of the loop with the mechanism or structure.

### ⚠️ WARNING

Failure to secure in accordance with instructions could lead to loss of the rope and/or injury.

- 3.14 When coiling a rope on a plain (or smooth) barrel drum ensure that each lap lies tightly against the preceding lap. The application of tension in the rope greatly assists in the coiling of the rope.

## Product Safety: Instructions & Warnings on the use of steel wire rope

### ⚠️ WARNING

Any looseness or uneven winding will result in excessive wear, crushing and distortion of the rope.

With plain barrel drums it is difficult to achieve satisfactory multi-layer coiling beyond three layers.

The direction of coiling of the rope on the drum is important, particularly when using plain barrel drums, and should be related to the direction of lay of the rope in order to induce close coiling.

(See Fig. 12 for proper method of locating rope anchorage point on a plain drum.)

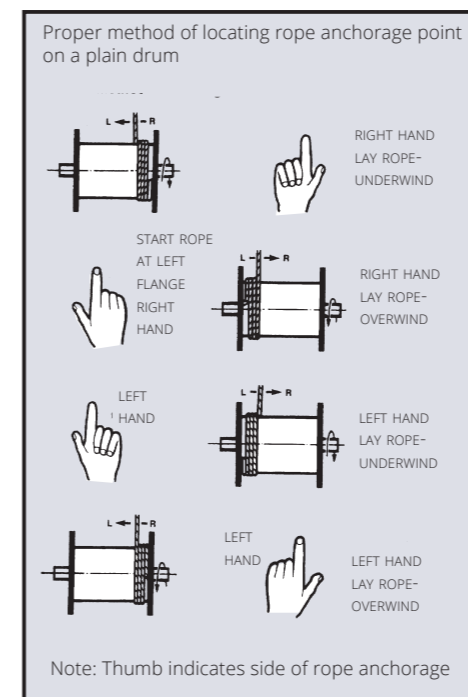

Fig 12

When multi-layer coiling has to be used it should be realised that after the first layer is wound on a drum, the rope has to cross the underlying rope in order to advance across the drum in the second layer. The points at which the turns in the upper layer cross those of the lower layer are known as the cross-over points and the rope in these areas is susceptible to increased abrasion and crushing. Care should be taken when installing a rope on a drum and when operating a machine to ensure that the rope is coiled and layered correctly.

- 3.15 Check the state of re-usable rope end terminations for size, strength, defects and cleanliness before use. Non-destructive testing may be required depending on the material and circumstances of use. Ensure that

the termination is fitted in accordance with the OEM's instruction manual or manufacturer's instructions.

When re-using a socket and depending on its type and dimensions, the existing cone should be pressed out. Otherwise, heat may be necessary.

### ⚠️ WARNING

When melting out sockets which have previously been filled with hot metal, the emission of toxic fumes is likely. Note that white metal contains a high proportion of lead.

Correctly locate and secure any connection pins and fittings when assembling end terminations to fixtures. Refer to manufacturer's instructions.

### ⚠️ WARNING

Failure to pay attention to any of the above could result in unsafe operation and potential injury.

- 3.16 Limit switches, if fitted, must be checked and re-adjusted, if necessary, after the rope has been installed.
- 3.17 Record the following details on the Certificate after installation has been completed: type of equipment, location, plant reference number, duty and date of installation and any re-rating information/signature of competent person. Then safely file the Certificate.
- 3.18 'Run in' the new rope by operating the equipment slowly, preferably with a low load, for several cycles. This permits the new rope to adjust itself gradually to working conditions.

Note: Unless otherwise required by a certifying authority, the rope should be in this condition before any proof test of the equipment or machinery is carried out.

Check that the new rope is spooling correctly on the drum and that no slack or cross laps develop.

If necessary, apply as much tension as possible to ensure tight and even coiling, especially on the first layer.

Where multi-layer coiling is unavoidable, succeeding layers should coil evenly on the preceding layers of rope.

## Product Safety: Instructions & Warnings on the use of steel wire rope

### ⚠️ WARNING

Irregular coiling usually results in severe surface wear and rope malformation, which in turn is likely to cause premature rope failure.

3.19 Ensure that the as-manufactured condition of the rope is maintained throughout the whole of the handling and installation operation.

3.20 If samples are required to be taken from the rope for subsequent testing and/or evaluation, it is essential that the condition of the rope is not disturbed. Refer to the instructions given in 3.12 and, depending on the rope type and construction, any other special manufacturer's instructions.

4. In Service

4.1 Inspect the rope and related equipment at the beginning of every work period and particularly following any incident which could have damaged the rope or installation.

The entire length of rope should be inspected and particular attention paid to those sections that experience has proven to be the main areas of deterioration. Excessive wear, broken wires, distortion and corrosion are the usual signs of deterioration. For a more detailed examination special tools are necessary (see Fig. 13) which will also facilitate internal inspection (see Fig. 14.)

Fig 13

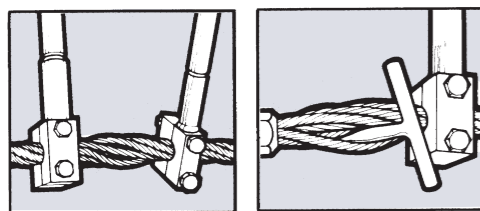
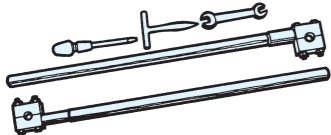

Fig 14

In the case of ropes working over drums or sheaves it is particularly necessary to examine those areas entering or leaving the grooves when maximum loads (i.e. shock loads) are experienced, or those areas which remain for long periods in exposed places such as over a head gear pulleys.

On some running ropes, but particularly relevant to standing ropes (e.g. guide ropes) the areas adjacent to terminations should be given special attention (see Fig. 14).

Note: Shortening the rope re-positions the areas of maximum deterioration in the system. Where conditions permit, begin operating with a rope which has a slightly longer length than necessary in order to allow for periodic shortening.

When a non-preformed rope, multi-layer rope or parallel closed rope is used with a wedge socket and is required to be shortened, it is essential that the end of the rope is secured by welding or brazing before the rope is pulled through the main body of the socket to its new position. Slacken the wedge in the socket. Pass the rope through the socket by an amount equivalent to the crop length or sample required. Note that the original bent portion of the rope must not be retained within the wedge socket. Replace the wedge and pull up the socket. Prepare and cut in accordance with section 3.12. Ensure that the rope tail cannot withdraw through the socket, see section 3.13.

### ⚠️ WARNING

Failure to observe this instruction will result in a significant deterioration in the performance of the rope and could render the rope completely unfit for further service.

In cases where severe rope wear takes place at one end of a wire rope, the life of the rope may be extended by changing round the drum end with the load end, i.e. turning the rope 'end for end' before deterioration becomes excessive.

4.2 Remove broken wires as they occur by bending backwards and forwards using a pair of pliers until they break deep in the valley between two outer strands (see Fig. 15). Wear protective clothing such as overalls, industrial gloves, helmet, eye protectors and safety footwear during this

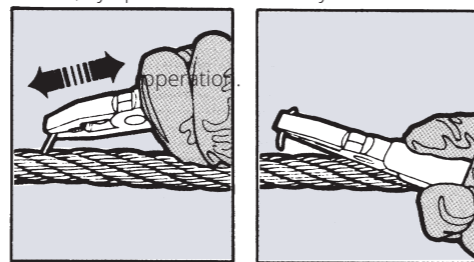

Fig 15

### ⚠️ WARNING

Do not shear off the ends of broken wires with pliers as this will leave an exposed jagged edge which is likely to damage other wires in the rope and lead to premature removal of the rope from service. Failure to wear adequate protective clothing could result in injury.

## Product Safety: Instructions & Warnings on the use of steel wire rope

Note: Broken wires are a normal feature of service, more so towards the end of the rope's life, resulting from bending fatigue and wear. The local break up of wires may indicate some mechanical fault in the equipment.

Record the number and position in the rope of any removed broken wires.

4.3 Do not operate an appliance if for any reason (e.g. rope diameter, certified breaking force, rope construction, length or strength and type of rope termination) the wire rope and its termination is considered unsuitable for the required duty.

4.4 Do not operate an appliance if the wire rope fitted has become distorted, been damaged or has deteriorated to a level such that discard criteria has been reached or is likely to be reached prior to normal expected life based on historical performance data.

### ⚠️ WARNING

Rope distortion is usually a result of mechanical damage and can significantly reduce rope strength.

4.5 An authorised competent person must examine the rope in accordance with the appropriate Regulations.

4.6 Do not carry out any inspection, examination, dressing/lubrication, adjustment or any other maintenance of the rope whilst it is suspending a load, unless otherwise stated in the OEM's instruction manual or other relevant documents.

Do not carry out any inspection or maintenance of the rope if the appliance controls are unattended unless the surrounding area has been isolated or sufficient warning signs have been posted within the immediate vicinity.

If the appliance controls are attended, the authorised person must be able to communicate effectively with the driver or controller of the appliance during the inspection process.

4.7 Never clean the wire rope without recognising the potential hazards associated with working on a moving rope.

### ⚠️ WARNING

Failure to pay attention or take adequate precaution could result in injury.

If cleaning by cloth/waste, the material can be snagged on damaged surfaces and/or broken wires. If cleaning by brush, eye protectors must be worn. If using fluids it should be recognised that some products are highly inflammable. A respirator should be worn if cleaning by a pressurised spray system.

### ⚠️ WARNING

Failure to take adequate precaution could result in injury or damage to health.

Only use compatible cleaning fluids which will not impair the original rope lubricant nor affect the rope associated equipment.

### ⚠️ WARNING

The use of cleaning fluids (particularly solvent based) is likely to 'cut back' the existing rope lubricant leading to a greater quantity of lubricant accumulating on the surface of the rope. This may create a hazard in appliances and machinery which rely on friction between the rope and the drive sheave (e.g. lifts, friction winders and cableways).

4.8 Lubricants selected for in-service dressing must be compatible with the rope manufacturing lubricant and should be referenced in the OEM's instruction manual or other documents approved by the owner of the appliance.

If in doubt contact the rope supplier or Bridon.

4.9 Take particular care when applying any in-service lubricant/dressing. Application systems which involve pressure should only be operated by trained and authorised persons and the operation carried out strictly in accordance with the manufacturer's instructions.

Most wire ropes should be lubricated as soon as they are put into service and at regular intervals thereafter (including cleaning) in order to extend safe performance.

### ⚠️ WARNING

A 'dry' rope unaffected by corrosion but subject to bend fatigue, is likely to achieve only 30% of that normally attained by a 'lubricated' rope.

Do not dress/lubricate the rope if the application required it to remain dry. (Refer OEM's instruction manual.)

Reduce the period between examinations when ropes are not subjected to any in-service dressing and when they must remain dry.

Note: The authorised person carrying out a rope inspection must be capable of recognising the potential loss of safe performance of such a rope in comparison with lubricated rope.

Clean the rope before applying a fresh dressing/lubricant if it is heavily loaded with foreign matter e.g. sand, dust.

## Product Safety: Instructions & Warnings on the use of steel wire rope

4.10 The authorised person responsible for carrying out wire rope maintenance must ensure that the ends of the rope are secure. At the drum end this will involve checking the integrity of the anchorage and ensuring that there are at least two and a half dead laps tightly coiled. At the outboard end the integrity of the termination must be checked to ensure that it is in accordance with the OEM's manual or other documents approved by the owner of the appliance.

Adjust the lengths of ropes in multi-rope systems in order that equal forces (within approved limits) are evident.

If a wire rope needs cutting refer to 3.12.

When securing rope ends refer to 3.13.

When re-usable end terminations are used refer to 3.15.

When re-connecting any end terminations to fixtures refer to 3.15.

### ⚠ WARNING

Damage to, or removal of component parts (mechanical or structural) caused by abnormal contact with wire rope can be hazardous to the safety of the appliance and/or the performance of the rope (e.g. damage to the drum grooving, such that coiling is erratic and/or the rope is 'pulled down' into underlying layers, which might cause a dangerous condition or, alternatively, cause localised rope damage at 'cross-over' positions, which might then radically affect performance; loss/removal of wear plates protecting the structure leading to major structural damage by cutting and/or failure of the wire rope due to mechanical severance).

4.12 Following any periodic statutory examination or routine or special inspection where any corrective action is taken the Certificate should be updated and a record made of the defects found, the extent of the changes and the condition of the rope.

4.13 Apply the following procedures for the selection and preparation of samples, from new and used lengths of rope, for the purpose of examination and testing to destruction.

Check that the rope end, from which the sample will be taken, is secured by welding or brazing. If not, select the sample length further away from the rope end and prepare new servings (see 3.12).

Handle the rope in accordance with the instructions given in section 3. Serve the rope, using the buried wire technique (see Fig. 10) and apply a rope clamp or grip as

close to the cut mark as practically possible. Do not use solder to secure the servings.

Ensure that the sample is kept straight throughout the whole procedure and ensure that the minimum sample length is 3 metres for ropes up to and including 40mm diameter and 12 metres for larger diameter ropes.

The rope should be cut with a high speed abrasive disc cutter or an oxyacetylene torch. Weld the rope ends of the sample as described in section 3.12, after which the clamp or grip can be removed.

The identification of the rope must be established and the sample suitably marked and packed. It is recommended that the 3 metre sample is retained straight and secured to a wood batten for transportation. For a 12 metre sample, coil to a diameter as large as practically possible and never less than 2 metres.

Note: Samples taken for destruction testing are required to be terminated in accordance with a recognised resin socketing standard (e.g. BS EN 13411-4 or ISO 7596).

### ⚠ WARNING

Failure to comply with these procedures will result in measured breaking force values which are not truly representative of the actual strength of the rope.

#### 5. Wire Rope Discard

5.1 Discard the wire rope in accordance with current Regulations and in accordance with the OEM's instruction manual.

5.2 If a wire rope is removed from service at a level of performance substantially different to historically established performance data and without any obvious reason(s), contact Bridon or Bridon's distributor for further guidance.

5.3 Only qualified and experienced personnel, taking the appropriate safety precautions and wearing the appropriate protective clothing, should be responsible for removing the wire rope.

### ⚠ WARNING

Take particular care when removing ropes with mechanical damage as they may fail abruptly during the change-out procedure.

## Product Safety: Instructions & Warnings on the use of steel wire rope

Take the utmost care when removing 'exhausted/failed' ropes from drums and sheaves as they may be grossly distorted, lively and tightly coiled.

### ⚠ WARNING

Failure to take adequate precautions could result in injury.

5.4 Store discarded rope in a safe and secure location or compound and ensure that it is suitably marked to identify it as rope which has been removed from service and not to be used again.

### ⚠ WARNING

Discarded rope can be a danger (e.g. protruding broken wires, excessive grease/lubricant and rope mass) to personnel and equipment if not handled correctly and safely during disposal.

5.5 Record the date and reason for discard on the Certificate before filing for future reference.

5.6 Pay attention to any Regulations affecting the safe disposal of steel wire rope.

#### 6. Rope Selection Criteria

Ensure that the correct type of wire rope is selected for the equipment by referring to the OEM's instruction manual or other relevant documents. If in doubt contact Bridon or Bridon's distributor for guidance.

#### 6.1 Rope Strength

If necessary, refer to the appropriate Regulations and/or application standards and calculate the maximum force to which the rope will be subjected.

The calculation may take into account the mass to be lifted or moved, any shock loading, effects of high speed, acceleration, any sudden starts or stops, frequency of operation and sheave bearing friction.

By applying the relevant coefficient of utilisation (safety factor) and, where applicable, the efficiency of the rope termination, the required minimum breaking load or force of the rope will be determined, the values of which are available from the relevant National, European or International standards or from specific Product Data literature. If in doubt ask for advice from Bridon or Bridon's distributor.

#### 6.2 Bending fatigue

The size and number of sheaves in the system will influence the performance of the rope.

### ⚠ WARNING

Wire rope which bends around sheaves, rollers or drum will deteriorate through 'bending fatigue'. Reverse bending and high speed will accelerate the process. Therefore, under such conditions select a rope with high bending fatigue resistance. Refer to Product Data Information, and if in doubt ask for advice.

#### 6.3 Abrasion

Wire rope which is subject to abrasion will become progressively weaker as a result of:

Externally - dragging it through overburden, sand or other abrasive materials and passing around a sheave, roller or drum.

### ⚠ WARNING

Abrasion weakens the rope by removing metal from both the inner and outer wires. Therefore, a rope with large outer wires should normally be selected.

#### 6.4 Vibration

Vibration in wire rope will cause deterioration. This may become apparent in the form of wire fractures where the vibration is absorbed.

### ⚠ WARNING

These fractures may be internal only and will not be visually identified.

#### 6.5 Distortion

Wire rope can be distorted due to high pressure against a sheave, improperly sized grooves or as a result of multi-layer coiling on a drum.

Rope with a steel core is more resistant to crushing and distortion.

#### 6.6 Corrosion

Rope with a large number of small wires is more susceptible to corrosion than rope with a small number of large wires. Therefore, if corrosion is expected to have a significant effect on rope performance select a galvanised rope with as large an outer wire size as possible bearing in mind the other conditions (e.g. bending and abrasion) under which the rope will be operating.

## Product Safety: Instructions & Warnings on the use of steel wire rope

### 6.7 Connecting Ropes

In the event that it is necessary to connect one rope to another (in series) it is essential that they have the required strength, are of the same type and both have the same lay direction (i.e. connect 'right' lay to 'right' lay).

#### ⚠ WARNING

Failure to heed this warning could result in catastrophic failure particularly at a termination which is capable of being pulled apart (i.e. splice) due to unlaying.

### 6.8 Rope Length

Rope length and /or difference in length between two or more ropes used in a set may be a critical factor and must be considered along with rope selection.

#### ⚠ WARNING

Wire rope will elongate under load. Other factors such as temperature, rope rotation and internal wear will also have an effect. These factors should also be considered during rope selection.

### 6.9 Preformed and Non-preformed Ropes

Single layer round strand rope is normally supplied preformed. However, if a non-preformed rope is selected then personnel responsible for its installation and/or maintenance need to take particular care when handling such rope, especially when cutting. For the purposes of this instruction, multi-layer, parallel closed and spiral ropes should be regarded as non-preformed ropes.

### 6.10 Operating Temperatures

Wire rope with a steel core should be selected if there is any evidence to suggest that a fibre core will not provide adequate support to the outer strands and/or if the temperature of the working environment may be expected to exceed 100 °C.

For operating temperatures above 100 °C de-rating of the minimum breaking force of the rope is necessary (e.g. between 100 °C and 200 °C reduce by 10%; between 200 °C and 300 °C reduce by 25%; between 300 °C and 400 °C reduce by 35%).

Do not use ropes with high carbon wires above 400 °C.

#### ⚠ WARNING

Failure to observe this general guidance could result in failure of the ropes to support the load.

For temperatures over 400 °C, other materials such as stainless steel or other special alloys should be considered.

#### ⚠ WARNING

Rope lubricants and any synthetic filling and/or covering materials may become ineffective at certain low or high operating temperature levels.

Certain types of rope end terminations also have limiting operating temperatures and the manufacturer or Bridon should be consulted where there is any doubt. Ropes with aluminium ferrules must not be used at temperatures in excess of 150 °C.

## Product Safety: Instructions & Warnings on the use of steel wire rope

#### ⚠ WARNING

CAUTIONARY NOTICE – RESTRICTIONS ON THE USE OF LARGE DIAMETER MULTI-STRAND ROPES.

All wire ropes are prone to damage if they are not properly supported when used at high loads. Larger Multi-strand ropes are particularly susceptible to this form of abuse, due to their rigid construction and the relatively fine wire sizes involved in their manufacture/construction. Instances have been recorded of ropes being heavily worked over plain drums and failing "prematurely", despite the nominal tension being

being in the region of half the breaking strength of the rope.

The best way of preventing difficulties of this sort is to avoid conditions that are likely to generate damagingly high contact stresses. A simple method of assessing the severity of the contact conditions is to firstly calculate the tread pressure based on the projected nominal area and then apply a factor (of say 10\*) to allow for the highly localised and intermittent nature of the actual wire contacts, as indicated below :-

Type of contact	Close-fitting U-groove	Oversize U-groove	Plain drum
Level of support	Good	Fair	Poor
Tread path width	100% of rope dia.	50% of rope dia.	20% of rope dia.
Tread pressure =	2T/Dd	4T/Dd	10T/Dd
Contact stress =	20T/Dd	40T/Dd	100T/Dd

Note: Contact stresses which exceed 10% of the wire UTS should be considered a cause for concern, especially if the rope is operating at a low factor of safety.

[\* This is because the true contact area is very much less than the projected nominal area.]

Worked example:

Consider case of a 50mm Multi-strand rope (MBL=2100kN) operating at a 3:1 factor of safety. Then, for the Contact stress < 200 Mpa say, the following minimum bending diameters are indicated:

Close-fitting groove - 1400mm  
Oversize U-groove - 2800mm  
Un-grooved drum - 7000mm



## Material Safety Data

### Introduction

Steel wire rope is a composite material and dependent upon its type may contain a number of discrete materials. The following provides full details of all the individual materials which may form part of the finished wire rope.

The description and/or designation of the wire rope stated on the delivery note and/or invoice (or certificate, when applicable) will enable identification of the component parts.

The main component of a steel wire rope is the wire, which may be carbon steel, coated (zinc or Zn95/A15) steel or stainless steel.

The other three components are (i) the core, which may be of steel of the same type as used in the main strands or alternatively fibre (either natural or synthetic), (ii) the rope

lubricant and, where applicable, (iii) any internal filling or external covering. No Occupational Exposure Limits (OEL's) exist for steel wire rope and the values provided in this publication relate to component elements and compounds. The actual figures quoted in relation to the component parts are taken from the latest edition of EH40.

Rope produced from carbon, coated or stainless steel wires in the as-supplied condition is not considered a health hazard. However during any subsequent processing such as cutting, welding, grinding and cleaning, dust and fumes may be produced which contain elements that may affect exposed workers.

The following indicates the order in which specific information is provided:-

Carbon steel wire, Coated steel wire, Stainless steel wire, Manufacturing rope lubricants, Fibre cores,

### Carbon Steel Wire - Hazardous Ingredients

Component	% Weight (Max)	Long term exposure limit (8-hour TWA reference period) mg/m <sup>3</sup>	Short term exposure limit (10-minute reference period) mg/m <sup>3</sup>
BASE METAL			
Aluminium	0.3	10	20
Carbon	1.0	None Listed	
Chromium	0.4	0.5	
Cobalt	0.3	0.1	
Copper	0.5	0.2	
Iron	Balance	5	10
Manganese	1.0	5	5
Molybdenum	0.1	5	10
Nickel	0.5	1	
Phosphorus	0.1	0.1	0.3
Silicon	0.5	10	
Sulphur	0.5	None Listed	
Vanadium	0.25	0.5	
Boron	0.1	10	20
Titanium	0.1	10	
Nitrogen	0.01	5	9
Lead	0.1	0.15	
Arsenic	0.01	0.2	
Zirconium	0.05	5	10
COATED			
Sodium	0.5	None Listed	
Calcium	0.5	2	
Boron	1.0	10	20
Phosphorus	1.0	0.1	0.3
Iron	1.0	5	10
Zinc	1.0	5	10
Oil may be applied	5.0	5	10

### Physical Data

Specific Gravity:	7.5 - 8.5	Vapour Pressure:	N/A
Melting Point:	1350 - 1500 °C	Vapour Density:	N/A
Appearance & Odour:	Solid, Odourless Metal	Evaporation:	N/A
Solubility in water:	Insoluble	% Volatiles:	N/A
Flash Point:	None	Boiling Point:	> 2800 °C

## Material Safety Data

### Coated (Zinc and Zn95/A 15) Steel Wire - Hazardous Ingredients

Component	% Weight (Max)	Long term exposure limit (8-hour TWA reference period) mg/m <sup>3</sup>	Short term exposure limit (10-minute reference period) mg/m <sup>3</sup>
BASE METAL			
Aluminium	0.3	10	20
Carbon	1.0	None Listed	
Chromium	0.4	0.5	
Cobalt	0.3	0.1	
Copper	0.5	0.2	
Iron	Balance	5	10
Manganese	1.0	5	5
Molybdenum	0.1	5	10
Nickel	0.5	1	
Phosphorus	0.1	0.1	0.3
Silicon	0.5	10	
Sulphur	0.5	None Listed	
Vanadium	0.25	0.5	
Boron	0.1	10	20
Titanium	0.1	10	
Nitrogen	0.01	5	9
Lead	0.1	0.15	
Arsenic	0.01	0.2	
Zirconium	0.05	5	10
COATED			
Zinc	10.0	5	10
Aluminium	1.5	10	20
Iron	5.0	5	10
Sodium	0.5	None Listed	
Calcium	0.5	2	
Boron	1.0	100	20
Phosphorus	1.0	0.1	0.3
Sulphur	0.5	None Listed	
Oil may be applied	5.0	5	10
Wax may be applied	5.0	2	6

### Physical Data

Specific Gravity:	7.5 - 8.5	Vapour Pressure:	N/A
Melting Point:	1350 - 1500 °C	Vapour Density:	N/A
Appearance & Odour:	Solid, Odourless Metal	Evaporation:	N/A
Solubility in water:	Insoluble	% Volatiles:	N/A
Flash Point:	None	Boiling Point:	> 2800 °C

## Material Safety Data

### Manufacturing Rope Lubricants

The products used in the manufacture of steel wire ropes for lubrication and protection present minimal hazard to the user in the as-supplied condition. The user must, however, take reasonable care to minimise skin and eye contact and also avoid breathing their vapours and mists.

A wide range of compounds is used as lubricants in the manufacture of steel wire rope. These products, in the main, consist of mixtures of oils, waxes, bitumens, resins, gelling agents and fillers with minor concentrations of corrosion inhibitors, oxidation stabilizers and tackiness additives.

Most of them are solid at ambient temperatures and provided skin contact with the fluid types is avoided, none present a hazard in normal rope usage.

However, to assist in the assessment of the hazard caused by these products, the following table contains all the components which may be incorporated into a wire rope lubricant and which may be considered hazardous to health.

### Hazardous Ingredients:

Component	Long term exposure limit (8-hour TWA reference period) mg/m <sup>3</sup>	Short term exposure limit (10-minute reference period) mg/m <sup>3</sup>
Oil mist	5	10
Paraffin wax fume	2	6
Bitumen	5	10
Silica, fused		
Total inhalable	0.3	
dust	0.1	
Respirable dust	10	20
Aluminium flake	5	10
Zinc oxide, fume	1430	1780

There are no other known constituents of any wire rope lubricant used that are classified as hazardous in the current edition of EH40.

### General advice on handling ropes with lubricants

To avoid the possibility of skin disorders, repeated or prolonged contact with mineral or synthetic hydrocarbons must be avoided and it is essential that all persons who come into contact with such products maintain high standards of personal hygiene.

The worker should:

- 1) use oil impermeable gloves, or if not available, suitable oil repellent type barrier creams,
- 2) avoid unnecessary contact with oil using protective clothing,
- 3) obtain first aid treatment for any injury, however slight,
- 4) wash hands thoroughly before meals, before using the toilet and after work,

- 5) use conditioning creams after washing, where provided.

The worker should not:

- 1) put oily rags or tools into pockets, especially trousers,
- 2) use dirty or spoiled rags for wiping oil from the skin,
- 3) wear oil soaked clothing,
- 4) use solvents such as paraffin, petrol etc., to remove oil from the skin.

Concentrations of oil mists, fumes and vapours in the working atmosphere must be kept as low as is reasonably practicable. Levels quoted in the current edition of HSE Guidance Note EH40 'Occupational Exposure Limits' must not be exceeded.

### Health Hazards

Inhalation of oil mists or fumes from heated rope lubricants in high concentrations may result in dizziness, headache, respiratory irritation or unconsciousness. Eye contact may produce mild transient irritation to some users.

Fumes from heated rope lubricants in high concentrations may cause eye irritation.

If heated rope lubricants contacts skin, severe burns may result.

Prolonged or repeated skin contact may cause irritation, dermatitis or more serious skin disorders.

### Fibre Cores

Being in the centre of a steel wire rope, the materials (natural or synthetic) from which fibre cores are produced do not present a health hazard during normal rope handling. Even when the outer core strands are removed (for example when the rope is required to be socketed) the core materials present virtually no hazard to the users, except, maybe, in the case of a used rope where, in the absence of any service dressing or as a result of heavy working causing internal abrasive wear of the core, the core may have decomposed into a fibre dust which might be inhaled, although this is considered extremely unlikely.

The principal area of hazard is through the inhalation of fumes generated by heat, for example when the rope is being cut by a disc cutter.

## Material Safety Data

Under these conditions, natural fibres are likely to yield carbon dioxide, water and ash, whereas synthetic materials are likely to yield toxic fumes.

The treatment of natural fibres, such as rotproofing, may also produce toxic fumes on burning.

The concentrations of toxic fumes from the cores, however, will be almost negligible compared with the products generated by heating from the other primary materials, e.g. wire and manufacturing lubricant in the rope.

The most common synthetic core material is polypropylene, although other polymers such as polyethylene and nylon may occasionally be used.

### Filling and Covering Materials

Filling and covering materials do not present a health hazard during handling of the rope in its as-supplied condition.

The principal area of hazard is by the inhalation of fumes generated by heat, for example when the rope is being cut by a disc cutter.

Under these conditions, fillings and coverings, which are generally polypropylene, polyethylene and polyamide (but in some cases may be of natural fibre) are likely to produce toxic fumes.

### General Information

#### Occupational protective measures

- 1) Respiratory protection - Use general and local exhaust ventilation to keep airborne dust or fumes below established occupational exposure standards (OES's). Operators should wear approved dust and fume respirators if OES's are exceeded. (The OES for total dust is 10mg/m<sup>3</sup> and for respirable dust is 5mg/m<sup>3</sup>).
- 2) Protective equipment - Protective equipment should be worn during operations creating eye hazards. A welding hood should be worn when welding or burning. Use gloves and other protective equipment when required.
- 3) Other - Principles of good personal hygiene should be followed prior to changing into street clothing or eating. Food should not be consumed in the working environment.

#### Emergency medical procedures

- 1) Inhalation - Remove to fresh air; get medical attention.
- 2) Skin - Wash areas well with soap and water.
- 3) Eyes - Flush well with running water to remove particulate; get medical attention.
- 4) Ingestion - In the unlikely event that quantities of rope or any of its components are ingested, get medical attention.

### Safety Information

- 1) Fire and explosion - In the solid state, steel components of the rope present no fire or explosion hazard. The organic elements present, i.e. lubricants, natural and synthetic fibres and other natural or synthetic filling and covering materials are capable of supporting fire.
- 2) Reactivity - Stable under normal conditions.

### Spill or leak procedures

- 1) Spill or leak - Not applicable to steel in the solid form.
- 2) Disposal - Dispose of in accordance with local Regulations.

## Rope Terminology

### Wires

**Outer wires:** All wires positioned in the outer layer of wires in a spiral rope or in the outer layer of wires in the outer strands of a stranded rope.

**Inner wires:** All wires of intermediate layers positioned between the centre wire and outer layer of wires in a spiral rope or all other wires except centre, filler, core and outer wires of a stranded rope.

**Core wires:** All wires of the core of a stranded rope.

**Centre wires:** Wires positioned either at the centre of a spiral rope or at the centres of strands of a stranded rope.

**Layer of wires:** An assembly of wires having one pitch circle diameter. The exception is Warrington layer comprising alternately laid large and small wires where the smaller wires are positioned on a larger pitch circle diameter than the larger wires. The first layer is that which is laid immediately over the strand centre.

Note: Filler wires do not constitute a separate layer.

**Tensile strength grade of wires:** A level of requirement of tensile strength of a wire and its corresponding tensile strength range. It is designated by the value according to the lower limit of tensile strength and is used when specifying wire and when determining the calculated minimum breaking force or calculated minimum aggregate breaking force of a rope.

**Wire finish:** The condition of the surface finish of a wire, e.g. bright, zinc coated.

# rope terminology.



## Rope Terminology

### Strands

Strand: An element of rope usually consisting of an assembly of wires of appropriate shape and dimensions laid helically in the same direction in one or more layers around a centre.

Note: Strands containing three or four wires in the first layer or certain shaped (e.g. ribbon) strands may not have a centre.

Round strand: A strand with a cross-section which is approximately the shape of a circle.

Triangular strand: A strand with a cross-section which is approximately the shape of a triangle.

Note: Triangular strands may have built-up centres (i.e. more than one wire forming a triangle).

Oval strand: A strand with a cross-section which is approximately the shape of an oval

Flat ribbon strand: A strand without a centre wire with a cross-section which is approximately the shape of a rectangle.

Compacted strand: A strand which has been subjected to a compacting process such as drawing, rolling or swaging whereby the metallic cross-sectional area of the wires remains unaltered and the shape of the wires and the dimensions of the strand are modified.

Note: Bridon's brands of Dyform rope contain strands which have been compacted.

Single lay strand: Strand which contains only one layer of wires, e.g. 6-1.

Parallel lay strand: Strand which contains at least two layers of wires, all of which are laid in one operation (in the same direction), e.g. 9-9-1; 12-6F-6-1; 14-7+7-7-1. Each layer of wires lies in the interstices of the underlying layer such that they are parallel to one another, resulting in linear contact.

Note: This is also referred to as equal lay. The lay length of all the wire layers are equal.

Seale: Parallel lay strand construction with the same number of wires in each wire layer, each wire layer containing wires of the same size, e.g. 7-7-1; 8-8-1; 9-9-1.

Warrington: Parallel lay strand construction having an outer layer of wires containing alternately large and small wires, the number of wires in the outer layer being twice that in the underlying layer of wires, e.g. 6+6-6-1; 7+7-7-1.

Filler: Parallel lay strand construction having an outer layer of wires containing twice the number of wires than in the inner layer with filler wires laid in the interstices wires of the underlying layer of wires, e.g. 12-6F-6-1; 14-7F-7-1.

Combined parallel lay: Parallel lay strand construction having three or more layers of wires, e.g. 14-7+7-7-1; 16-8+8-8-1; 14-14-7F-7-1; 16-16-8F+8-1.

Note: The first two examples above are also referred to as Warrington-Seale construction. The latter two examples are also referred to as Seale-Filler construction.

Multiple operation lay strand: Strand construction containing at least two layers of wires, at least one of which is laid in a separate operation. All of the wires are laid in the same direction.

Cross-lay: Multiple operation strand construction in which the wires of superimposed wire layers cross over one another and make point contact, e.g. 12/6-1.

Compound lay: Multiple operation strand which contains a minimum of three layers of wires, the outer layer of which is laid over a parallel lay centre, e.g. 16/6+6-6-1.

### Ropes

Spiral Rope: An assembly of two or more layers of shaped and/or round wires laid helically over a centre, usually a single round wire. There are three categories of spiral rope, viz. spiral strand, half-locked coil and full-locked coil.

Spiral Strand: An assembly of two or more layers of round wires laid helically over a centre, usually a single round wire.

Half-locked Coil Rope: A spiral rope type having an outer layer of wires containing alternate half lock and round wires.

Full-locked Coil Rope: A spiral rope type having an outer layer of full lock wires.

Stranded Rope: An assembly of several strands laid helically in one or more layers around a core or centre. There are three categories of stranded rope, viz. single layer, multi-layer and parallel-closed.

Single Layer Rope: Stranded rope consisting of one layer of strands laid helically over a core.

Note: Stranded ropes consisting of three or four outer strands may, or may not, have a core. Some three and four strand single layer ropes are designed to generate torque levels equivalent to those generated by rotation-resistant and low rotation ropes.

Rotation-resistant Rope: Stranded rope having no less than ten outer strands and comprising an assembly of at least two layers of strands laid over a centre, the direction of lay of the outer strands being opposite (i.e. contra - lay) to that of the underlying layer of strands.

Low Rotation Rope: Rotation resistant rope having at least fifteen outer strands and comprising an assembly of at least three layers of strands laid over a centre in two operations.

Note: this category of rotation resistant rope is constructed in such a manner that it displays little or no tendency to rotate, or if guided, generates little or no torque when loaded.



# BRIDON • BEKAERT

T H E R O P E S G R O U P

[contact@bridon-bekaert.com](mailto:contact@bridon-bekaert.com)

[www.bridon-bekaert.com](http://www.bridon-bekaert.com)



[facebook.com/BridonBekaert](https://facebook.com/BridonBekaert)



[linkedin.com/company/bridon-bekaert](https://linkedin.com/company/bridon-bekaert)



[twitter.com/bridonbekaert](https://twitter.com/bridonbekaert)

Canada

+1 514-697-9711

United States

1-800-521-5555

570-822-3349

United Kingdom

+44(0) 1302 565100

LATAM

+55-11-2147-8942 /

+55-22-98147-1400

## DISCLAIMER

Whilst every effort has been made to ensure the accuracy of information in this publication, no guarantee or warranty (express or implied) is given with respect to the accuracy or completeness of the information contained within. This publication and the products described herein may be changed or updated without notice. Any and all liability whatsoever for any loss or damage arising, directly or indirectly, out of or in connection with the use of this publication, is excluded to the fullest extent permitted by law. The user must determine the suitability of the product for their own particular purpose, either alone or in combination with other products and shall assume all risk and liability in connection therewith. This document is published by Bridon-Bekaert Ropes Group. Use of this publication shall be governed in accordance with the laws of England & Wales and the English courts shall have exclusive jurisdiction over any dispute concerning your use of this publication.

## INTELLECTUAL PROPERTY

All rights reserved. No parts of this publication may be reproduced or transmitted in any form or by any means without the prior written permission of the copyright holder, application for which should be addressed to Bridon-Bekaert Ropes Group. All trademarks used in this publication belong to Bridon-Bekaert Ropes Group or the registered proprietors of such marks. All rights relating to such trademarks, copyright and any other intellectual property rights are reserved for "Bridon" or the person/organisation contributing the relevant materials.